

1. 適用範圍 / SCOPE

此規格書是溫度保險絲 TE 型系列，適合用於一般電化產品、電熱器產品、廚房機器、電動機及線圈類…產品。

This specification applies to thermal cutoff : TE Series, which use in electrochemical product、electric heater、kitchen equipment、power equipment and coil product.

2. 產品型號 / TYPE

例「example」：

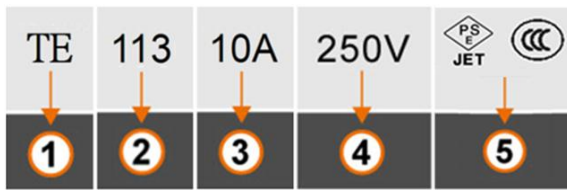

- ① 系列號/ Series Number
- ② 額定動作溫度/Rated Functioning Temperature
- ③ 額定電流/ Rated Current
- ④ 額定電壓/ Rated Voltage
- ⑤ 認證符號/Approved Symbol

3. 額定電流、額定電壓及溫度規格 / RATED CURRENT, RATED VOLTAGE AND TEMPERATURE TYPE

3-1 額定電流 / Ampere Rating: 10A

3-2 額定電壓 / Voltage Rating: 250V AC

3-3 額定動作溫度 / Rated Functioning Temperature (T_F)





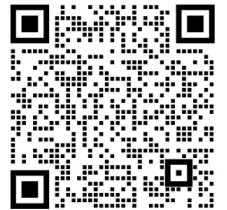

最高極限溫度 / Maximum Temperature Limit (T_M)

最高維持溫度 / Holding Temperature Limit (T_H)

實際動作溫度 / Cut-off Temperature

見下表 / See Table:

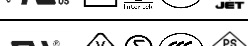

型號 Type No.	額定動作溫度 TF .Tf (°C) Rated Functioning Temperature	實測動作 溫度(°C) Cut-off Temperature	最高維持溫度 TH. TC (°C) Holding Temperature Limit	最高極限溫度 TM . Tm (°C) Maximum Temperature Limit	電氣額定值 Electrical Ratings		安規認證符號 Safety approval mark
					電流(A) Current	電壓(V) Voltage	
TE66	66	64±2	42	200	10A	250V	
TE77	77	74±2	48	200	10A	250V	
TE87	87	81±2	52	200	10A	250V	
TE94	94	91±2	62	160	10A	250V	
TE99	99	96±2	68	200	10A	250V	
TE103	103	97±2.5	68	200	10A	250V	
TE113	113	108±2	81	200	10A	250V	
TE116	116	111±2.5	83	200	10A	250V	

型號 Type No.	額定動作溫度 TF .Tf (°C) Rated Functioning Temperature	實測動作 溫度(°C) Cut-off Temperature	最高維持溫度 TH . TC (°C) Holding Temperature Limit	最高極限溫度 TM . Tm (°C) Maximum Temperature Limit	電氣額定值 Electrical Ratings		安規認證符號 Safety approval mark
					電流(A) Current	電壓(V) Voltage	
TE121	121	118.5±2.5	86	200	10A	250V	
TE128	128	126±2	100	250	10A	250V	
TE139	139	135±2	109	200	10A	250V	
TE142	142	135±2	110	200	10A	250V	
TE147	147	142±2	117	250	10A	250V	
TE152	152	150±2	122	250	10A	250V	
TE169	169	164±2	139	300	10A	250V	
TE184	184	181.5±2	154	300	10A	250V	
TE185	185	181.5±2	154	300	10A	250V	
TE187	187	181.5±2	154	300	10A	250V	
TE216	216	213±2	186	300	10A	250V	
TE240	240	236±2	200	300	10A	250V	

4. 標示 / MARKING

溫度保險絲上需有下列標示 / The Thermal Cutoffs shall have the following marking:

- ① 製造工廠的標識 / Manufacture' s Logo:
- ② 型號 / Type: TE
- ③ 額定動作溫度 / Rated Functioning Temperature(T_F): ____°C
- ④ 額定電流 / Ampere Rating(A) : 10A
- ⑤ 額定電壓 / Voltage Rating(V) : 250V~
- ⑥ 批號 / Date Code : XX
- ⑦ 認證符號 / Approval Marks

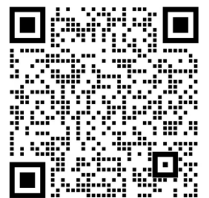

TE66 :

TE77~TE184、TE216、TE240 :

TE185、TE187 :

注意 / NOTE: 對標示的 大小和位置沒有規定 / Size and position of the markings shall not be provided.



5. 外觀及形狀 / APPEARANCES AND CONFIGURATION

5-1 外觀不應有顯著的汙點、鐵銹或裂紋；標示應該容易辨識。

There shall not be any remarkable stain, rust or crack on the appearances; marking shall be easily legible.

5-2 形狀：帶直線引腳的溫度保險絲。

Configuration : Radial Leaded Thermal Cutoffs.

6. 工程圖和結構 / OUTLINE DRAWING AND STRUCTURE

6-1 工程圖（單位：mm） / Outline Drawing and Dimensions (Unit: mm)

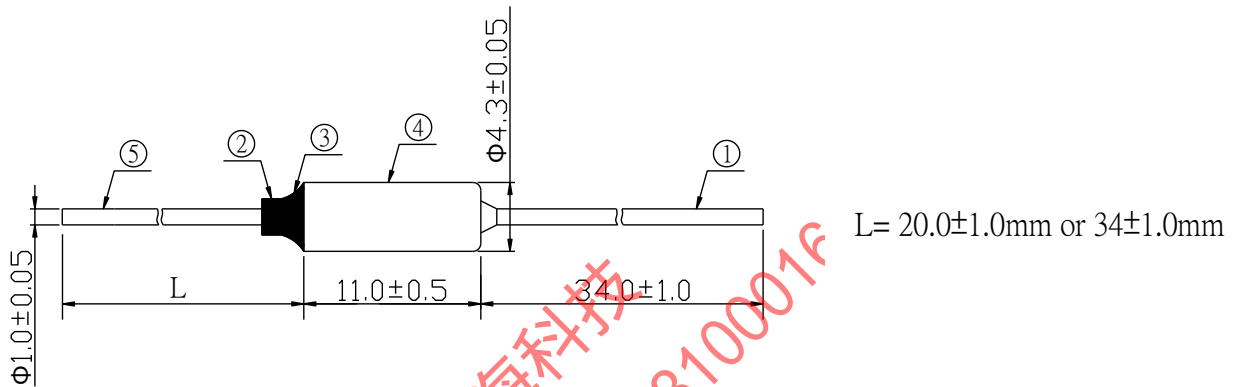

6-2 結構 / Structure

編號 No.	元件 Component	材質 Material	數量 Quantity
1	引線 1 Lead	鍍錫銅線 Tin Plated Copper	1
2	絕緣管 Isolation Tube	金黃色陶瓷 Golden Ceramic	1
3	封口樹脂 Sealing Resin	環氧樹脂 Epoxy Resin	~
4	外殼 Casing	黃銅鍍銀 Silver Plated Brass	1
5	引線 2 Lead	鍍銀銅線 Silver Plated Copper	1

7. 產品特性 / PRODUCT CHARACTERISTICS

7-1 拉力 / Pull

溫度保險絲樣品以任何不致傷害到它的方便方式支撐起來，用 15.7N 的拉力作用到每一隻引線腳上達 1 分鐘，每隻引線腳都不能斷裂或鬆開。

The thermal cutoff is to be supported in any convenient manner so as not to damage it and a pull force as 15.7N to each lead for 1 minutes.

7-2 推力 / Push

溫度保險絲樣品以任何不致傷害到它的方便方式支撐起來，用 3.9N 的推力作用到每一隻引線腳上達 1 分鐘，每隻引線腳都不能斷裂或鬆開。

The thermal cutoff is to be supported in any convenient manner so as not to damage it and a push force as 3.9N to each lead for 1 minutes.

7-3 扭轉力 / Twist

溫度保險絲樣品以任何不致傷害到它的方便方式支撐起來，在每一隻引線腳上距離溫度保險絲本體 10 mm 的地方折一個 90 度角，然後照下圖所說明的樣子扭轉 180 度，每隻引線腳都不能斷裂或鬆開。

The thermal cutoff is to be rigidly supported so as not to damage it. Each lead is to be bent through 90 degrees at a location 10 mm from the body of thermal cutoff and then twisted through 180 degrees.

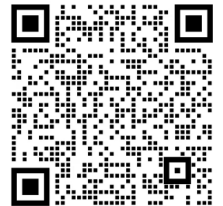
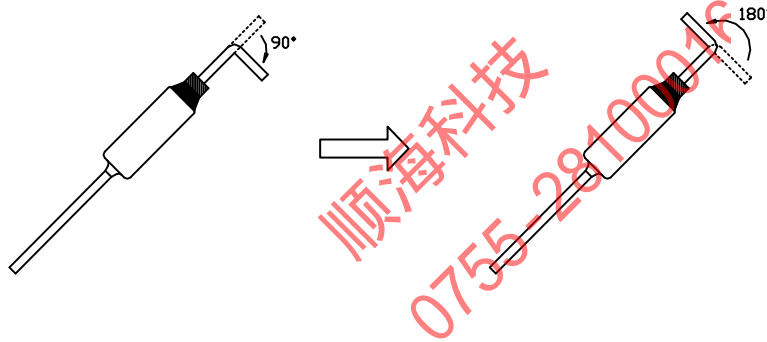

7-4 垂直壓力 / Vertical pressure

垂直作用於溫度保險絲本體外殼的壓力應小於或等於 10kgf (98N)。

The strength applied to the body of the thermal cutoff should be 10kgf(98N) or less.

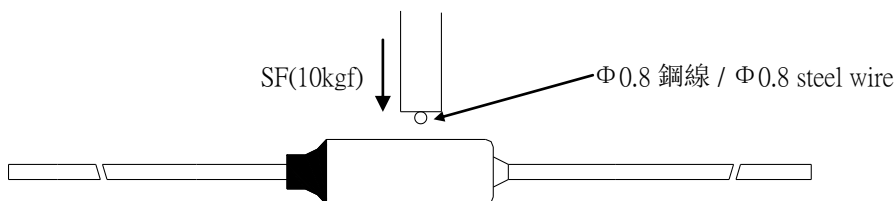

8. 溫度特性 / TEMPERATURE CHARACTERISTICS

8-1 額定動作溫度 (TF.Tf) / Rated Functioning Temperature

當僅有不大於 10 mA 的偵測電流作為負載的情況下，使溫度保險絲改變其導電狀態之溫度，此溫度公差在+0，-10°C 範圍以內。

The temperature at which a thermal cutoff changes its state of conductivity to open a circuit with detection current of 10mA or less as the only load .The temperature tolerance is +0,-10°C.

8-2 實際動作溫度 / Cut-off Temperature

溫度保險絲在以升溫速率為 0.5~1°C/min，且以不高於 10mA 的偵測電流偵測烤爐中動作時的溫度。

Cut-off temperature is the actual operating temperature range when the thermal cutoff is made to operate inside a constant temperature oven whose temperature is raised at the rate of 0.5 to 1°C/min, while a detection current of 10mA or lower is applied.

8-3 保持溫度 (TH.Th.TC) / Holding Temperature

在溫度保險絲中，通以額定電流能夠連續維持 168 小時導通狀態，在此情況下，溫度保險絲所能夠承受的不致改變電氣導通狀態的最高溫度。

The maximum temperature at which a thermal cutoff can be maintained while conducting rated current for 168 hours without functioning.

8-4 最高極限溫度 (TM.Tm) / Maximum Temperature Limit

溫度保險絲所能處在的最高溫度，在這個高溫狀態下，溫度保險絲已改變其電氣導通性，溫度保險絲在這個高溫持續達 10 分鐘而不致破壞其機械性能和電氣特性。

The maximum temperature at which mechanical and electrical properties of a thermal cutoff can be maintained for 10 minutes without resuming conductivity after functioning.

8-5 存儲條件 / Storage Conditions

溫度 / temperature : -10°C ~ 40°C

相對濕度 / Humidity : 75%以下 (年平均)，在無露水的情況下，保存 30 天的最大相對濕度為 95%。

Relative humidity \leq 75% yearly average, without dew, maximum value for 30 days -95%.

9. 電氣特性 / ELECTRICAL CHARACTERISTICS

9-1 絕緣阻抗 / Insulation Resistance

以額定電壓值兩倍的直流電壓為測量電壓，斷開點之間的絕緣阻抗至少要有 0.2MΩ；斷電的通路點與外殼之間的絕緣阻抗至少要有 2MΩ。

The insulation resistance is to be measured with a DC Voltage of twice the rated voltage, and at least 0.2MΩ across the disconnection; current path and the enclosures is not less than 2 MΩ.

9-2 耐高電壓測試 / Dielectric Voltage-Withstand Test

溫度保險絲斷電的通路點之間，可承受兩倍額定電壓值 1 分鐘以上；溫度保險絲帶電部件與外殼之間，可承受兩倍額定電壓+1000V 1 分鐘以上。

A thermal cutoff shall withstand double the rated voltage for 1 minute without breakdown ; Live parts and enclosure $2U_r+1000V$ for 1 minute without breakdown.

10. 安裝方式及條件 / INSTALLATION WAY AND PARAMETERS

溫度保險絲在使用、加工處理或安裝時，請特別注意以下幾點：

Please pay attention to the following notices when the thermal cutoff is used.



10-1 使用 / Cautions

- a. 請在額定電壓、額定電流內使用溫度保險絲。

Use the thermal cutoff with a voltage and current level lower than the rated level.

- b. 請勿當作電流保險絲使用。

Don't use this device for and purpose other than as a thermal cutoff.

- c. 請勿在水、有機溶劑液體及亞硫酸氣體或高濕環境下使用。

Don't use the thermal cutoff in water, organic solvents or other liquids, or environments containing sulfurous acid gas, nitrous acid gas, or high humidity.

10-2 引線處理 / Lead wire process

- a. 引線進行曲折加工時，請先在離本體 3mm 以上處固定后再進行曲折加工。

The lead wire should be bent at distance 3 mm or more from the body of the fuse.

- b. 作業時，不要向引線施加過大的拉力，推力或扭力。

Don't be careful to apply force that may pull, push or twist to the lead wires.

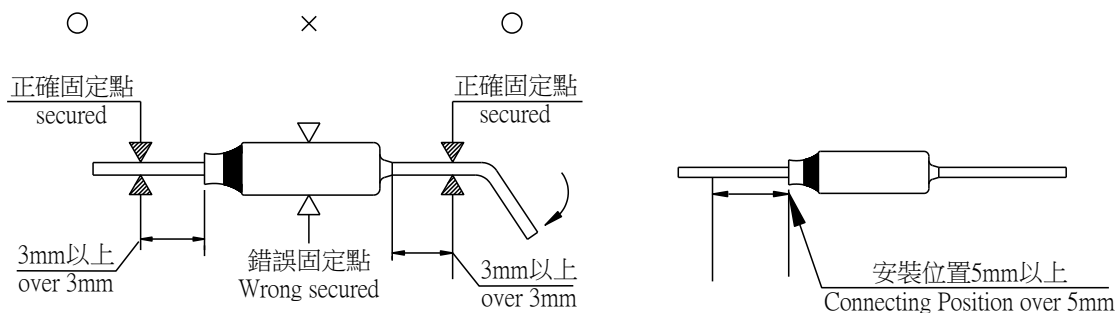



10-3 安裝 / Mounting

- a. 溫度保險絲可以用焊接、鉚合等方式進行安裝。

The thermal cutoff can be mounted by soldering, caulking, or welding.

- b. 建議使引線（樹脂封口側）的安裝位置離開本體 5mm 以上。

It is recommended that the connecting position at the lead of resin-sealed side should be 5 mm or more from the body of the thermal cutoff.

- c. 如果是用焊接方式安裝：為防止焊接時的熱量引發保險絲動作，在焊接時，建議用散熱夾，夾在保險絲外殼附近，以便熱量散發，並在規定的焊錫時間內完成，具體焊錫時間如下表：

If soldering ,note that the thermal cutoff may not function because of excessive solder temperature. To prevent such malfunctions, for example, holding the lead near the case by tool is effective for allowing the heat to escape, and the soldering should be done in short interval.

Tf 溫度 Tf Temp.	引線距離 Lead Distance	焊錫時間 Soldering time			焊錫條件 Soldering Conditions
		10mm	15mm	20mm	
94°C 以下 / 94°C down		1s	2s	3s	焊錫溫度：300°C Soldering Temperature: 300°C
94°C ~100°C		2s	3s	4s	
101°C ~130°C		3s	4s	5s	
130°C 以上 / over 130°C		4s	5s	5s	

注意：焊錫後 30 秒內不可進行如拉、扭、彎曲等加工。

Attention: After soldering ,wait at least 30 seconds before resoldering, taping, securing, or repositioning the TCO.

- d. 如用鉚接的方法安裝，請勿使連接處電阻過大，以防止通過電流時異常發熱，導致溫度保險絲動作。

If caulking or welding ,be careful to keep the resistance value of the connecting section low. If the connecting section has a high resistance value, the passing current may generate an abnormally high temperature that will cause the thermal cutoff to operate.

11. 其他使用注意事項 / OTHER NOTICE IN USED

符合本公司可能的其他檔的要求。

It could be in conformance with another file, which made by our company.

12. 安全認證及編號 / STANDARDS AND APPROVALS

UL	E212625
VDE	40005865
SEMKO	1811351
PSE	JET2179-32001-2004(TE66、TE77) JET2179-32001-2009 (TE87、TE94、TE99) JET2179-32001-2005 (TE103、TE113、TE116) JET2179-32001-2006 (TE121、TE128、TE139) JET2179-32001-2007 (TE142、TE147、TE152) JET2179-32001-2008 (TE216)
CCC	2019010205177728

13. 包裝 / PACKING

散裝每膠袋 100 個保險絲
 每盒 10 袋共 1000 個保險絲
 Bulk 100 pcs / poly bag
 10 poly bags / box, altogether 1000 pcs

順海科技
0755-28100016



14. 其他 / OTHERS

14-1 如果在使用中有超出本規格書的要求，必須經由雙方協商確認。

In the event that an impropriety is found beyond this specification ,it shall be fixed by mutual agreement between the parties.

14-2 如果本規格書有不適當的情況，必須通過雙方協商並由本公司修改。

In the event that an impropriety is found in this specification , WALTER ELECTRONIC CO., LTD. shall amend it by mutual agreement between the parties.

版次	製作	確認	審核
第八版	饒 紅	蔡明威	Eris Kuo



IMPROVED CERTIFICATIONS SEARCH TOOL. REGISTER NOW!

[▶ LEARN MORE](#)

XCMQ2.E212625 Thermal Links - Component

If you notice a change to your XCMQ2 Listing Card, click [here](#) to learn more.

[Page Bottom](#)

Thermal Links - Component

[See General Information for Thermal Links - Component](#)

SUZHOU WALTER ELECTRONIC CO LTD

E212625

Fenhu Technic Development Zone
Wujiang, Jiangsu 215211 CHINA

Model(s) TB102, TB115, TB125, TB130, TB150, TD102, TD115, TD125, TD130, TE103, TE113, TE116, TE121, TE128, TE139, TE142, TE147, TE152, TE169, TE184, TE185, TE187, TE216, TE240, TE66, TE77, TE87, TE94, TE99, TG103, TG113, TG116, TG121, TG128, TG139, TG142, TG147, TG152, TG169, TG184, TG187, TG240, TG66, TG77, TG87, TG94, TG99

NOTE - All models investigated to UL60691.

Marking: Company name or tradename "Walter" or trademark  and model designation.

[Last Updated](#) on 2018-06-13

[Questions?](#)

[Print this page](#)

[Terms of Use](#)

[Page Top](#)

© 2018 UL LLC

The appearance of a company's name or product in this database does not in itself assure that products so identified have been manufactured under UL's Follow-Up Service. Only those products bearing the UL Mark should be considered to be Certified and covered under UL's Follow-Up Service. Always look for the Mark on the product.

UL permits the reproduction of the material contained in the Online Certification Directory subject to the following conditions: 1. The Guide Information, Assemblies, Constructions, Designs, Systems, and/or Certifications (files) must be presented in their entirety and in a non-misleading manner, without any manipulation of the data (or drawings). 2. The statement "Reprinted from the Online Certifications Directory with permission from UL" must appear adjacent to the extracted material. In addition, the reprinted material must include a copyright notice in the following format: "© 2018 UL LLC".

ZEICHENGENEHMIGUNG MARKS APPROVAL

Suzhou Walter Electronic
Co. Ltd.
Fenhu Technic Development Zone
215211 LUXU TOWN, WUJIANG CITY
Jiangsu
CHINA

ist berechtigt, für ihr Produkt /
is authorized to use for their product

Temperatursicherung
Thermal link

die hier abgebildeten markenrechtlich geschützten Zeichen
für die ab Blatt 2 aufgeführten Typen zu benutzen /
the legally protected Marks as shown below for the types referred to on page 2 ff.



Geprüft und zertifiziert nach /
Tested and certified according to

DIN EN 60691 (VDE 0821):2017-04; EN 60691:2016
IEC 60691:2015

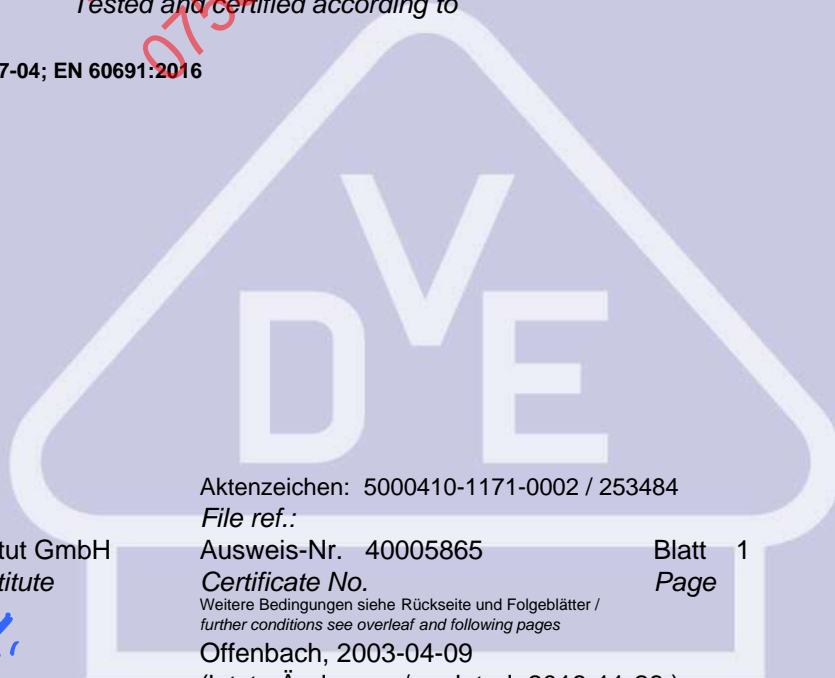

Aktenzeichen: 5000410-1171-0002 / 253484

File ref.:

Ausweis-Nr. 40005865

Blatt 1

Certificate No.

Page

Weitere Bedingungen siehe Rückseite und Folgeblätter /
further conditions see overleaf and following pages

Offenbach, 2003-04-09

(letzte Änderung / updated 2018-11-28)

VDE Prüf- und Zertifizierungsinstitut GmbH
VDE Testing and Certification Institute
Zertifizierungsstelle / Certification

M. Tasotti

VDE Zertifikate sind nur gültig bei Veröffentlichung unter:
VDE certificates are valid only when published on:

<http://www.vde.com/zertifikat>
<http://www.vde.com/certificate>

Name und Sitz des Genehmigungs-Inhabers / Name and registered seat of the Certificate holder

Suzhou Walter Electronic Co. Ltd., Fenuh Technic Development Zone, 215211 LUXU TOWN, WUJIANG CITY,
Jiangsu, CHINA

Aktenzeichen / File ref.

5000410-1171-0002 / 253484 / TL3 / EUL

letzte Änderung / updated

2018-11-28

Datum / Date

2003-04-09

Dieses Blatt gilt nur in Verbindung mit Blatt 1 des Zeichengenehmigungsausweises Nr. 40005865.

This supplement is only valid in conjunction with page 1 of the Certificate No. 40005865.

Temperatursicherung

Thermal link

Typ(en) / Type(s)	Bemessungsschalt- Temperatur Rated functioning temperature	Max. Grenztemperatur Max. temperature limit	Dauerbetriebstemperatur r Holding temperature
TG77 / TE77	77 °C	200 °C	48 °C
TG87 / TE87	87 °C	200 °C	52 °C
TG94 / TE94	94 °C	160 °C	62 °C
TG99 / TE99	99 °C	200 °C	68 °C
TG103 / TE103	103 °C	200 °C	68 °C
TG113 / TE113	113 °C	200 °C	81 °C
TG116 / TE116	116 °C	200 °C	83 °C
TG121 / TE121	121 °C	200 °C	86 °C
TG128 / TE128	128 °C	250 °C	100 °C
TG139 / TE139	139 °C	200 °C	109 °C
TG142 / TE142	142 °C	200 °C	110 °C
TG147 / TE147	147 °C	250 °C	117 °C
TG152 / TE152	152 °C	250 °C	122 °C
TG169 / TE169	169 °C	300 °C	139 °C
TG184 / TE184	184 °C	300 °C	154 °C
TG216 / TE216	216 °C	300 °C	186 °C
TG240 / TE240	240 °C	300 °C	200 °C

Bemessungsspannung
Rated voltage

AC 125 V / AC 250 V

Bemessungsstrom
Rated current

15 A (TG-serie(s))
10 A (TE-serie(s))

Zur Verwendung in
For use in

ohmschen Stromkreisen $\cos \phi > 0,95$
resistive circuits $\cos \phi > 0,95$

induktiven Stromkreisen $0,6 < \cos \phi < 0,95$
inductive circuits $0,6 < \cos \phi < 0,95$

Kriechstromfestigkeit
Tracking resistance

PTI 250

Fortsetzung siehe Blatt 3 /
continued on page 3

VDE Prüf- und Zertifizierungsinstitut Zeichengenehmigung

Ausweis-Nr. / Blatt /
Certificate No. / Page
40005865 3

Name und Sitz des Genehmigungs-Inhabers / *Name and registered seat of the Certificate holder*

Suzhou Walter Electronic Co. Ltd., Fenu Technic Development Zone, 215211 LUXU TOWN, WUJIANG CITY,
Jiangsu, CHINA

Aktenzeichen / *File ref.*

5000410-1171-0002 / 253484 / TL3 / EUL

letzte Änderung / *updated*

2018-11-28

Datum / *Date*

2003-04-09

Dieses Blatt gilt nur in Verbindung mit Blatt 1 des Zeichengenehmigungsausweises Nr. 40005865.

This supplement is only valid in conjunction with page 1 of the Certificate No. 40005865.

Art der Montage
Method of mounting

Einbau
built-in

Dieser Zeichengenehmigungs-Ausweis bildet eine Grundlage für die EG-Konformitätserklärung und CE-Kennzeichnung durch den Hersteller oder dessen Bevollmächtigten und bescheinigt die Konformität mit den grundlegenden Schutzanforderungen der **EG-Niederspannungsrichtlinie 2014/35/EU**.

*This Marks Approval is a basis for the EC Declaration of Conformity and the CE Marking by the manufacturer or his agent and proves the conformity with the essential safety requirements of the **EC Low-Voltage Directive 2014/35/EU**.*

VDE Prüf- und Zertifizierungsinstitut GmbH
VDE Testing and Certification Institute
Fachgebiet TL3
Section TL3

顺海科技
0755-28100016

Name und Sitz des Genehmigungs-Inhabers / *Name and registered seat of the Certificate holder*

Suzhou Walter Electronic Co. Ltd., Fenuh Technic Development Zone, 215211 LUXU TOWN, WUJIANG CITY,
Jiangsu, CHINA

Aktenzeichen / *File ref.*

5000410-1171-0002 / 253484 / TL3 / EUL

letzte Änderung / *updated*

2018-11-28

Datum / *Date*

2003-04-09

Dieses Beiblatt ist Bestandteil des Zeichengenehmigungsausweises Nr. 40005865.

This supplement is part of the Certificate No. 40005865.

Temperatursicherung

Thermal link

Fertigungsstätte(n)

Place(s) of manufacture

Referenz/*Reference*
30006375

Dongguan Walter Electric Co., Ltd.
Yan Tian, Feng Gang Town
523702 DONGGUAN CITY
Guangdong
CHINA

Referenz/*Reference*
30011941

Suzhou Walter Electronic
Co. Ltd.
Fenuh Technic Development Zone
215211 LUXU TOWN, WUJIANG CITY
Jiangsu
CHINA

VDE Prüf- und Zertifizierungsinstitut GmbH
VDE Testing and Certification Institute
Fachgebiet TL3
Section TL3

VDE Prüf- und Zertifizierungsinstitut Zeichengenehmigung

Ausweis-Nr. / Infoblatt /
Certificate No. / Info sheet
40005865

Name und Sitz des Genehmigungs-Inhabers / Name and registered seat of the Certificate holder

Suzhou Walter Electronic Co. Ltd., Fenuh Technic Development Zone, 215211 LUXU TOWN, WUJIANG CITY, Jiangsu, CHINA

Aktenzeichen / File ref.

5000410-1171-0002 / 253484 / TL3 / EUL

letzte Änderung / updated

2018-11-28

Datum / Date

2003-04-09

Dieses Blatt gilt nur in Verbindung mit Blatt 1 des Zeichengenehmigungsausweises Nr. 40005865.

This supplement is only valid in conjunction with page 1 of the Certificate No. 40005865.

Genehmigung zum Benutzen des auf Seite 1 abgebildeten markenrechtlich geschützten Zeichens des VDE:

Grundlage für die Benutzung sind die Allgemeinen Geschäftsbedingungen (AGB) der VDE Prüf- und Zertifizierungsinstitut GmbH (www.vde.com\AGB-Institut). Das Recht zur Benutzung erstreckt sich nur auf die bezeichnete Firma mit den genannten Fertigungsstätten und die oben aufgeführten Produkte mit den zugeordneten Bezeichnungen. Die Fertigungsstätte muss so eingerichtet sein, dass eine gleichmäßige Herstellung der geprüften und zertifizierten Ausführung gewährleistet ist.

Die Genehmigung ist so lange gültig wie die VDE-Bestimmungen gelten, die der Zertifizierung zugrunde gelegen haben, sofern sie nicht auf Grund anderer Bedingungen aus der VDE Prüf- und Zertifizierungsordnung (PM102) zurückgezogen werden muss.

Der Gültigkeitszeitraum einer VDE-GS-Zeichengenehmigung kann auf Antrag verlängert werden. Bei gesetzlichen und / oder normativen Änderungen kann die VDE-GS-Zeichengenehmigung ihre Gültigkeit zu einem früheren als dem angegebenen Datum verlieren.

Produkte, die das Biozid Dimethylfumarat (DMF) enthalten, dürfen gemäß der Kommissionsentscheidung 2009/251/EG nicht mehr in den Verkehr gebracht oder auf dem Markt bereitgestellt werden.

Der VDE-Zeichengenehmigungsausweis wird ausschließlich auf der ersten Seite unterzeichnet.

Approval to use the legally protected Mark of the VDE as shown on the first page:

Basis for the use are the general terms and conditions of the VDE Testing and Certification Institute (www.vde.com\terms-institute). The right to use the mark is granted only to the mentioned company with the named places of manufacture and the listed products with the related type references. The place of manufacture shall be equipped in a way that a constant manufacturing of the certified construction is assured.

The approval is valid as long as the VDE specifications are in force, on which the certification is based on, unless it is withdrawn according to the VDE Testing and Certification Procedure (PM102E).

The validity period of a VDE-GS-Mark Approval may be prolonged on request. In case of changes in legal and / or normative requirements, the validity period of a VDE-GS-Mark Approval may be shortened.

Products containing the biocide dimethylfumarate (DMF) may not be marketed or made available on the EC market according to the Commission Decision 2009/251/EC.

The approval is solely signed on the first page.



IMPROVED CERTIFICATIONS SEARCH TOOL. REGISTER NOW!

[LEARN MORE](#)

XCMQ8.E212625 Thermal Links Certified for Canada - Component

If you notice a change to your XCMQ8 Listing Card, click [here](#) to learn more.

[Page Bottom](#)

Thermal Links Certified for Canada - Component

[See General Information for Thermal Links Certified for Canada - Component](#)

SUZHOU WALTER ELECTRONIC CO LTD

E212625

Fenhu Technic Development Zone
Wujiang, Jiangsu 215211 CHINA

Model(s) TB102, TB115, TB125, TB130, TB150, TD102, TD115, TD125, TD130, TE103, TE113, TE116, TE121, TE128, TE139, TE142, TE147, TE152, TE169, TE184, TE185, TE187, TE216, TE240, TE66, TE77, TE87, TE94, TE99, TG103, TG113, TG116, TG121, TG128, TG139, TG142, TG147, TG152, TG169, TG184, TG187, TG240, TG66, TG77, TG87, TG94, TG99

NOTE - All models investigated to UL60691.

Marking: Company name or tradename "Walter" or trademark  , model designation and the Recognized

Component Mark for Canada, 

[Last Updated](#) on 2018-06-13

[Questions?](#)

[Print this page](#)

[Terms of Use](#)

[Page Top](#)

© 2018 UL LLC

The appearance of a company's name or product in this database does not in itself assure that products so identified have been manufactured under UL's Follow-Up Service. Only those products bearing the UL Mark should be considered to be Certified and covered under UL's Follow-Up Service. Always look for the Mark on the product.

UL permits the reproduction of the material contained in the Online Certification Directory subject to the following conditions: 1. The Guide Information, Assemblies, Constructions, Designs, Systems, and/or Certifications (files) must be presented in their entirety and in a non-misleading manner, without any manipulation of the data (or drawings). 2. The statement "Reprinted from the Online Certifications Directory with permission from UL" must appear adjacent to the extracted material. In addition, the reprinted material must include a copyright notice in the following format: "© 2018 UL LLC".

顺海科技
0755-28100016

Certificate



Intertek

for European Product Safety

Reference No. 1811351

Thermal-link for appliances

Type designation	TE*, TG*
Certificate holder	Suzhou Walter Electronic Co., Ltd. Fenhu Technic Development Zone Wujiang, Jiangsu CHINA
The product complies with the standard(s)	EN 60691:2016
Date of expiry	3 September 2023
EU Directive information	According to the principle of presumption of conformity, this certificate constitutes support for an EC Declaration of Conformity and CE marking according to the Low Voltage Directive 2014/35/EU.

Additional information in Appendix.

Certification Body	Intertek Semko AB, Product Certification	Place	Kista - Stockholm
Signed	 Bo Berglöv	Date	3 September 2018

Page 1 of 3

This certificate is issued in accordance with the terms and conditions set out in the Appendix.

SSU



Intertek Appendix

Reference No. 1811351

Technical data

Type designation: TE..	66	77	87	94	99	103	113	116	121	128	139	142	147	152	169	184	185	187	216	240
Rated voltage (V) <i>Ur</i> :	125/250VAC																			
Rated current (A) <i>Ir</i> :	10(10)A																			
Rated functioning temperature Tf: °C	66	77	87	94	99	103	113	116	121	128	139	142	147	152	169	184	185	187	216	240
Holding temperature Th: °C	42	48	52	62	68	68	81	83	87	100	104	110	117	122	152	154	154	154	178	200
Maximum temperature limit Tm: °C	200	200	200	160	200	200	200	200	200	250	200	200	250	250	300	300	300	300	246	300
Interrupting current (A) <i>Ib</i> :	15(15)A																			
Transient overload current (A) <i>Ip</i> :	150A																			
Resistant to tracking PTI (V)	> 250																			
Brand name																				
Product information:	Thermal links series TE*, where the * is the rated functioning temperature. Heat sensitive element – organic material.																			

Type designation: TG..	66	77	87	94	99	103	113	116	121	128	139	142	147	152	169	184	187	240	
Rated voltage (V) <i>Ur</i> :	125/250VAC																		
Rated current (A) <i>Ir</i> :	15(15)A																		
Rated functioning temperature Tf: °C	66	77	87	94	99	103	113	116	121	128	139	142	147	152	169	184	187	240	
Holding temperature Th: °C	42	48	52	62	68	68	81	83	87	100	104	110	117	122	152	154	154	200	
Maximum temperature limit Tm: °C	200	200	200	160	200	200	200	200	200	250	200	200	250	250	300	300	300	300	
Interrupting current (A) <i>Ib</i> :	22,5(22,5)A																		
Transient overload current (A) <i>Ip</i> :	225A																		
Resistant to tracking PTI (V)	> 250																		
Brand name																			
Product information:	Thermal links series TG*, where the * is the rated functioning temperature. Heat sensitive element – organic material.																		

This Certificate is for the exclusive use of Intertek's Client and is provided pursuant to the Certification agreement between Intertek and its Client. Intertek's responsibility and liability are limited to the terms and conditions of the agreement. Intertek assumes no liability to any party, other than to the Client in accordance with the agreement, for any loss, expense or damage occasioned by the use of this certificate. Only the Client is authorized to permit copying or distribution of this certificate and then only in its entirety. Use of Intertek's Certification mark is restricted to the conditions laid out in the agreement. Any further use of the Intertek name for the sale or advertisement of the tested material, product or service must first be approved in writing by Intertek. Initial Factory Assessments and Follow up Services are for the purpose of assuring appropriate usage of the Certification mark in accordance with the agreement, they are not for the purposes of production quality control and do not relieve the Client of their obligations in this respect.



Intertek Appendix

Reference No. 1811351

Manufacturing site(s) Suzhou Walter Electronic Co., Ltd.
Fenhu Technic Development Zone
Wujiang, Jiangsu
CHINA

Dongguan Walter Electric Co., Ltd
Yan Tian, Feng Gang Town
523702 DongGuan City
Guangdong
CHINA

According to the principle of presumption of conformity, this certificate, which includes production control, constitutes support for an EC Declaration of Conformity and CE marking according to the Low Voltage Directive 2014/35/EU.

This presumption can expire before end of validity of this certificate due to new issued Standard or Amendment and changes within the EU legislation.

This certificate is based on CB with ref. No. US-31002-A1-UL dated 2018-05-31, issued by UL.

This certificate replaces previously issued ref. No. 1414101 dated 21 November 2014.

A new certificate has been issued on account of renewal, change of certificate holder and addition of one manufacturing site.

Certification Body Intertek Semko AB, Product Certification **Place** Kista - Stockholm

Signed 
Bo Berglör **Date** 3 September 2018

This Certificate is for the exclusive use of Intertek's Client and is provided pursuant to the Certification agreement between Intertek and its Client. Intertek's responsibility and liability are limited to the terms and conditions of the agreement. Intertek assumes no liability to any party, other than to the Client in accordance with the agreement, for any loss, expense or damage occasioned by the use of this certificate. Only the Client is authorized to permit copying or distribution of this certificate and then only in its entirety. Use of Intertek's Certification mark is restricted to the conditions laid out in the agreement. Any further use of the Intertek name for the sale or advertisement of the tested material, product or service must first be approved in writing by Intertek. Initial Factory Assessments and Follow up Services are for the purpose of assuring appropriate usage of the Certification mark in accordance with the agreement, they are not for the purposes of production quality control and do not relieve the Client of their obligations in this respect.

SSU



中国国家强制性产品认证证书

证书编号：2019010205177728

委托人名称、地址

苏州华德电子有限公司
江苏省吴江市汾湖经济技术开发区(芦墟)

生产者(制造商)名称、地址

苏州华德电子有限公司
江苏省吴江市汾湖经济技术开发区(芦墟)

生产企业名称、地址

苏州华德电子有限公司
江苏省吴江汾湖经济开发区新黎路99号

产品名称和系列、规格、型号

热熔断体

见附件

产品标准和技术要求

GB/T9816.1-2013

上述产品符合强制性产品认证实施规则 CNCA-C02-01:2014 的要求，特发此证。

发证日期：2019年05月05日 有效期至：2024年05月05日
证书有效期内本证书的有效性依据发证机构的定期监督获得保持。

本证书的相关信息可通过国家认监委网站 www.cnca.gov.cn 查询



主任：

陆梅



中国质量认证中心



CERTIFICATE FOR CHINA COMPULSORY PRODUCT CERTIFICATION

CERTIFICATE NO.: 2019010205177728

NAME AND ADDRESS OF THE APPLICANT

Suzhou Walter Electronic Co., Ltd.
Fenhu Technic Development Zone, Luxu, Wujiang City, Jiangsu

NAME AND ADDRESS OF THE MANUFACTURER

Suzhou Walter Electronic Co., Ltd.
Fenhu Technic Development Zone, Luxu, Wujiang City, Jiangsu

NAME AND ADDRESS OF THE FACTORY

Suzhou Walter Electronic Co., Ltd.
No. 99 Xinli Road, Fenhu Technic Development Zone, Luxu, Wujiang City, Jiangsu

PRODUCT NAME, MODEL AND SPECIFICATION

Thermal-links

See Appendix

THE STANDARDS AND TECHNICAL REQUIREMENTS FOR THE PRODUCTS

GB/T9816.1-2013

This is to certify that the above mentioned product(s) complies with the requirements of implementation rules for compulsory certification(REFNO.CNCA-C02-01:2014).

Valid from: May.05,2019

Valid until: May.05,2024

The validity of the certificate is subject to positive result of the regular follow up inspection by issuing certification body until the expiry date.

The certificate information is available through CNCA's website: www.cnca.gov.cn



President:

Lu Mei



CHINA QUALITY CERTIFICATION CENTRE



中国国家强制性产品认证证书

附 录

第 1 页 共 1 页

证书编号：2019010205177728

纸 号：2283258

产品名称：热熔断体

型 号：TE77 Tf:77oC, Th:48oC, Tm:200oC; TE87 Tf:87oC, Th:52oC, Tm:200oC;
 TE94 Tf:94oC, Th:62oC, Tm:160oC; TE99 Tf:99oC, Th:68oC, Tm:200oC;
 TE103 Tf:103oC, Th:68oC, Tm:200oC; TE113 Tf:113oC, Th:81oC, Tm:200oC;
 TE116 Tf:116oC, Th:83oC, Tm:200oC; TE121 Tf:121oC, Th:86oC, Tm:200oC;
 TE128 Tf:128oC, Th:100oC, Tm:250oC; TE139 Tf:139oC, Th:109oC, Tm:200oC;
 TE142 Tf:142oC, Th:110oC, Tm:200oC; TE147 Tf:147oC, Th:117oC, Tm:250oC;
 TE152 Tf:152oC, Th:122oC, Tm:250oC; TE169 Tf:169oC, Th:139oC, Tm:300oC;
 TE184 Tf:184oC, Th:154oC, Tm:300oC; TE216 Tf:216oC, Th:186oC, Tm:300oC;
 TE240 Tf:240oC, Th:200oC, Tm:300oC; 125V AC 10A / 250V AC 10A 电阻性负
 载/电感性负载 PTI 250
 TG77 Tf:77oC, Th:48oC, Tm:200oC; TG87 Tf:87oC, Th:52oC, Tm:200oC;
 TG94 Tf:94oC, Th:62oC, Tm:160oC; TG99 Tf:99oC, Th:68oC, Tm:200oC;
 TG103 Tf:103oC, Th:68oC, Tm:200oC; TG113 Tf:113oC, Th:81oC, Tm:200oC;
 TG116 Tf:116oC, Th:83oC, Tm:200oC; TG121 Tf:121oC, Th:86oC, Tm:200oC;
 TG128 Tf:128oC, Th:100oC, Tm:250oC; TG139 Tf:139oC, Th:109oC, Tm:200oC;
 TG142 Tf:142oC, Th:110oC, Tm:200oC; TG147 Tf:147oC, Th:117oC, Tm:250oC;
 TG152 Tf:152oC, Th:122oC, Tm:250oC; TG169 Tf:169oC, Th:139oC, Tm:300oC;
 TG184 Tf:184oC, Th:154oC, Tm:300oC; TG216 Tf:216oC, Th:186oC, Tm:300oC;
 TG240 Tf:240oC, Th:200oC, Tm:300oC; 125V AC 15A / 250V AC 15A 电阻性负
 载/电感性负载 PTI 250

注：此附录与证书同时使用时有效。



主 任：陆 楠



中国质量认证中心

適合同等証明書

Statement of Conformity Assessment

電気用品安全法第8条第1項に規定する技術基準及び同法第9条第2項の経済産業省令で定める基準（法第9条第1項第2号に係る検査に係るものに限る）に適合していることを証明します

I hereby certify that the product mentioned below complies with the technical requirements stipulated in Paragraph 1 of Article 8 of Electrical Appliances and Materials Safety Act (here under referred to as the Act) and the requirements defined by the ordinance of the Ministry of Economy, Trade and Industry based on Paragraph 2 of Article 9 of the Act (limited to Item 2 of Paragraph 1 of Article 9 for Inspection of the Act).

1. 証明書番号: JET2179-32001-2004
Statement Number
2. 交付年月日: 2019年6月26日
Effective Date June 26, 2019
3. 有効年月日: 2026年6月25日
Date of Validity June 25, 2026
4. 申込者名 (Applicant)
住所: FENHU TECHNIC DEVELOPMENT ZONE WUJIANG, JIANGSU PROVINCE, CHINA
Address

氏名又は名称: SUZHOU WALTER ELECTRONIC CO., LTD.
Name

5. 特定電気用品名: 温度ヒューズ
Name of Product Thermal links
6. 型式の区分: 別紙のとおり
Type Classification See attached "Type Classification"
7. 製造工場名 (Manufacturer)
住所: FENHU TECHNIC DEVELOPMENT ZONE WUJIANG, JIANGSU PROVINCE, CHINA
Address

氏名又は名称: SUZHOU WALTER ELECTRONIC CO., LTD.
Name

8. 適用試験規格: 電気用品の技術上の基準を定める省令の解釈
Applied Standard for Testing Description of the technical requirements by the METI Ordinance
別表第十二 J60691 (H28)

Appendix 12 J60691 (H28)

9. 適合性検査の方法: (Testing Method for Conformity Assessment)
 - 1) 試験用の特定電気用品については、電気用品の技術上の基準を定める省令の解釈に定める方法
With respect to testing for Category A products, the testing method is based on the technical requirements of the description of Electrical Appliances and Materials stipulated in the METI Ordinance.
 - 2) 当該特定電気用品に係る届出事業者又は事業場における検査設備については、電気用品安全法施行規則別表第四の検査設備の欄に掲げる検査設備ごとにそれぞれ同表の技術上の基準の欄に掲げる方法
With respect to inspection facilities required for Category A products at the factory, Testing Method described in the column of the technical requirements for each inspection facilities in the column of inspection facilities is shown in the Appendix 4 of Enforcement Regulations of the Act.

10. 注意事項

- 1) この適合同等証明書は、提出された試験用の電気用品に関して評価を行った上で交付したものであり、同一の型式の区分にある電気用品について電気用品安全法第8条1項に規定する技術基準適合確認の義務を履行したことを示すものではありません。

This Statement of Conformity Assessment, which is issued on the evaluation of the submitted test-use Electrical Appliances and Materials, does not signify that the Obligation to Comply with Requirements, which is prescribed at Paragraph 1 of Article 8 of the Act, is fulfilled on Electrical Appliances and Materials in the same Type Classification.

- 2) この適合同等証明書は、別紙に記載されている型式の区分の範囲内及び区分の組み合わせについてのみ有効です。

This Statement of Conformity Assessment is valid only for Electrical Appliances and Materials within the Type Classifications and their combination as stated in the attached "Type Classification".

順海科技
0755-2810001F

一般財団法人 電気安全環境研究所
Japan Electrical Safety & Environment technology Laboratories (JET)

理事長 薦田 康久
President Yasuhisa Komoda

東京都渋谷区代々木5-14-12
(5-14-12, Yoyogi, Shibuya-ku, Tokyo, Japan)

証明書番号：JET2179-32001-2004

適合同等証明書別紙

Statement of Conformity Assessment

型式の区分

Type Classification

要素 Factor	区分 Classification
定格電圧 Rated voltage	(2) 125Vを超えるもの Exceeding 125V
定格電流 Rated current	(2) 5Aを超え15A以下のもの Exceeding 5A, and less than or equal to 15A
公称動作温度 Nominal operating temperature	(1) 80°C以下のもの 80°C or less
可溶体への通電 Current to fuse element	(2) ないもの No
可溶体の主材料 Fuse element materials	(3) 合成樹脂又は有機化合物のもの Plastic or organic compound
容器 Container	(1) あるもの With container
端子 Terminals	(2) 線付きのもの Wire lead
可溶体の形状 Shape of fuse element	(2) 塊状のもの Block

順海科技
0755-2810001F

証明書番号：JET2179-32001-2004

適合同等証明書

Statement of Conformity Assessment

電気用品安全法第8条第1項に規定する技術基準及び同法第9条第2項の経済産業省令で定める基準（法第9条第1項第2号に係る検査に係るものに限る）に適合していることを証明します

I hereby certify that the product mentioned below complies with the technical requirements stipulated in Paragraph 1 of Article 8 of Electrical Appliances and Materials Safety Act (here under referred to as the Act) and the requirements defined by the ordinance of the Ministry of Economy, Trade and Industry based on Paragraph 2 of Article 9 of the Act (limited to Item 2 of Paragraph 1 of Article 9 for Inspection of the Act).

1. 証明書番号: JET2179-32001-2005
Statement Number
2. 交付年月日: 2019年6月26日
Effective Date June 26, 2019
3. 有効年月日: 2026年6月25日
Date of Validity June 25, 2026
4. 申込者名 (Applicant)
住所: FENHU TECHNIC DEVELOPMENT ZONE WUJIANG, JIANGSU PROVINCE, CHINA
Address

氏名又は名称: SUZHOU WALTER ELECTRONIC CO., LTD.
Name

5. 特定電気用品名: 温度ヒューズ
Name of Product Thermal links
6. 型式の区分: 別紙のとおり
Type Classification See attached "Type Classification"
7. 製造工場名 (Manufacturer)
住所: FENHU TECHNIC DEVELOPMENT ZONE WUJIANG, JIANGSU PROVINCE, CHINA
Address

氏名又は名称: SUZHOU WALTER ELECTRONIC CO., LTD.
Name

8. 適用試験規格: 電気用品の技術上の基準を定める省令の解釈
Applied Standard for Testing Description of the technical requirements by the METI Ordinance
別表第十二 J60691 (H28)

Appendix 12 J60691 (H28)

9. 適合性検査の方法: (Testing Method for Conformity Assessment)
 - 1) 試験用の特定電気用品については、電気用品の技術上の基準を定める省令の解釈に定める方法
With respect to testing for Category A products, the testing method is based on the technical requirements of the description of Electrical Appliances and Materials stipulated in the METI Ordinance.
 - 2) 当該特定電気用品に係る届出事業者又は事業場における検査設備については、電気用品安全法施行規則別表第四の検査設備の欄に掲げる検査設備ごとにそれぞれ同表の技術上の基準の欄に掲げる方法
With respect to inspection facilities required for Category A products at the factory, Testing Method described in the column of the technical requirements for each inspection facilities in the column of inspection facilities is shown in the Appendix 4 of Enforcement Regulations of the Act.

10. 注意事項

- 1) この適合同等証明書は、提出された試験用の電気用品に関して評価を行った上で交付したものであり、同一の型式の区分にある電気用品について電気用品安全法第8条1項に規定する技術基準適合確認の義務を履行したことを示すものではありません。

This Statement of Conformity Assessment, which is issued on the evaluation of the submitted test-use Electrical Appliances and Materials, does not signify that the Obligation to Comply with Requirements, which is prescribed at Paragraph 1 of Article 8 of the Act, is fulfilled on Electrical Appliances and Materials in the same Type Classification.

- 2) この適合同等証明書は、別紙に記載されている型式の区分の範囲内及び区分の組み合わせについてのみ有効です。

This Statement of Conformity Assessment is valid only for Electrical Appliances and Materials within the Type Classifications and their combination as stated in the attached "Type Classification".

順海科技
0755-2810001F

一般財団法人 電気安全環境研究所
Japan Electrical Safety & Environment technology Laboratories (JET)

理事長 薦田 康久
President Yasuhisa Komoda

東京都渋谷区代々木5-14-12
(5-14-12, Yoyogi, Shibuya-ku, Tokyo, Japan)

証明書番号：JET2179-32001-2005

適合同等証明書別紙

Statement of Conformity Assessment

型式の区分

Type Classification

要素 Factor	区分 Classification
定格電圧 Rated voltage	(2) 125Vを超えるもの Exceeding 125V
定格電流 Rated current	(2) 5Aを超え15A以下のもの Exceeding 5A, and less than or equal to 15A
公称動作温度 Nominal operating temperature	(3) 100°Cを超え120°C以下のもの Exceeding 100°C, and less than or equal to 120°C
可溶体への通電 Current to fuse element	(2) ないもの No
可溶体の主材料 Fuse element materials	(3) 合成樹脂又は有機化合物のもの Plastic or organic compound
容器 Container	(1) あるもの With container
端子 Terminals	(2) 線付きのもの Wire lead
可溶体の形状 Shape of fuse element	(2) 塊状のもの Block

順海科技
0755-2810001P

証明書番号：JET2179-32001-2005

適合同等証明書

Statement of Conformity Assessment

電気用品安全法第8条第1項に規定する技術基準及び同法第9条第2項の経済産業省令で定める基準（法第9条第1項第2号に係る検査に係るものに限る）に適合していることを証明します

I hereby certify that the product mentioned below complies with the technical requirements stipulated in Paragraph 1 of Article 8 of Electrical Appliances and Materials Safety Act (here under referred to as the Act) and the requirements defined by the ordinance of the Ministry of Economy, Trade and Industry based on Paragraph 2 of Article 9 of the Act (limited to Item 2 of Paragraph 1 of Article 9 for Inspection of the Act).

1. 証明書番号: JET 2179-32001-2006
Statement Number
2. 交付年月日: 2019年6月26日
Effective Date June 26, 2019
3. 有効年月日: 2026年6月25日
Date of Validity June 25, 2026
4. 申込者名 (Applicant)
住所: FENHU TECHNIC DEVELOPMENT ZONE WUJIANG, JIANGSU PROVINCE, CHINA
Address

氏名又は名称: SUZHOU WALTER ELECTRONIC CO., LTD.
Name

5. 特定電気用品名: 温度ヒューズ
Name of Product Thermal links
6. 型式の区分: 別紙のとおり
Type Classification See attached "Type Classification"
7. 製造工場名 (Manufacturer)
住所: FENHU TECHNIC DEVELOPMENT ZONE WUJIANG, JIANGSU PROVINCE, CHINA
Address

氏名又は名称: SUZHOU WALTER ELECTRONIC CO., LTD.
Name

8. 適用試験規格: 電気用品の技術上の基準を定める省令の解釈
Applied Standard for Testing Description of the technical requirements by the METI Ordinance
別表第十二 J60691 (H28)

Appendix 12 J60691 (H28)

9. 適合性検査の方法: (Testing Method for Conformity Assessment)

- 1) 試験用の特定電気用品については、電気用品の技術上の基準を定める省令の解釈に定める方法

With respect to testing for Category A products, the testing method is based on the technical requirements of the description of Electrical Appliances and Materials stipulated in the METI Ordinance.

- 2) 当該特定電気用品に係る届出事業者又は事業場における検査設備については、電気用品安全法施行規則別表第四の検査設備の欄に掲げる検査設備ごとにそれぞれ同表の技術上の基準の欄に掲げる方法

With respect to inspection facilities required for Category A products at the factory, Testing Method described in the column of the technical requirements for each inspection facilities in the column of inspection facilities is shown in the Appendix 4 of Enforcement Regulations of the Act.

10. 注意事項

- 1) この適合同等証明書は、提出された試験用の電気用品に関して評価を行った上で交付したものであり、同一の型式の区分にある電気用品について電気用品安全法第8条1項に規定する技術基準適合確認の義務を履行したことを示すものではありません。

This Statement of Conformity Assessment, which is issued on the evaluation of the submitted test-use Electrical Appliances and Materials, does not signify that the Obligation to Comply with Requirements, which is prescribed at Paragraph 1 of Article 8 of the Act, is fulfilled on Electrical Appliances and Materials in the same Type Classification.

- 2) この適合同等証明書は、別紙に記載されている型式の区分の範囲内及び区分の組み合わせについてのみ有効です。

This Statement of Conformity Assessment is valid only for Electrical Appliances and Materials within the Type Classifications and their combination as stated in the attached "Type Classification".

順海科技
0755-28100016

一般財団法人 電気安全環境研究所
Japan Electrical Safety & Environment technology Laboratories (JET)

理事長 薦田 康久
President Yasuhisa Komoda

東京都渋谷区代々木5-14-12
(5-14-12, Yoyogi, Shibuya-ku, Tokyo, Japan)

証明書番号：JET2179-32001-2006

適合同等証明書別紙

Statement of Conformity Assessment

型式の区分

Type Classification

要素 Factor	区分 Classification
定格電圧 Rated voltage	(2) 125Vを超えるもの Exceeding 125V
定格電流 Rated current	(2) 5Aを超え15A以下のもの Exceeding 5A, and less than or equal to 15A
公称動作温度 Nominal operating temperature	(4) 120°Cを超え140°C以下のもの Exceeding 120°C, and less than or equal to 140°C
可溶体への通電 Current to fuse element	(2) ないもの No
可溶体の主材料 Fuse element materials	(3) 合成樹脂又は有機化合物のもの Plastic or organic compound
容器 Container	(1) あるもの With container
端子 Terminals	(2) 線付きのもの Wire lead
可溶体の形状 Shape of fuse element	(2) 塊状のもの Block

順海科技
0755-28100018

適合同等証明書

Statement of Conformity Assessment

電気用品安全法第8条第1項に規定する技術基準及び同法第9条第2項の経済産業省令で定める基準（法第9条第1項第2号に係る検査に係るものに限る）に適合していることを証明します

I hereby certify that the product mentioned below complies with the technical requirements stipulated in Paragraph 1 of Article 8 of Electrical Appliances and Materials Safety Act (here under referred to as the Act) and the requirements defined by the ordinance of the Ministry of Economy, Trade and Industry based on Paragraph 2 of Article 9 of the Act (limited to Item 2 of Paragraph 1 of Article 9 for Inspection of the Act).

1. 証明書番号: JET2179-32001-2007
Statement Number
2. 交付年月日: 2019年6月26日
Effective Date June 26, 2019
3. 有効年月日: 2026年6月25日
Date of Validity June 25, 2026
4. 申込者名 (Applicant)
住所 (Address): FENHU TECHNIC DEVELOPMENT ZONE WUJIANG, JIANGSU PROVINCE, CHINA

氏名又は名称: SUZHOU WALTER ELECTRONIC CO., LTD.
Name

5. 特定電気用品名: 温度ヒューズ
Name of Product Thermal links
6. 型式の区分: 別紙のとおり
Type Classification See attached "Type Classification"
7. 製造工場名 (Manufacturer)
住所 (Address): FENHU TECHNIC DEVELOPMENT ZONE WUJIANG, JIANGSU PROVINCE, CHINA

氏名又は名称: SUZHOU WALTER ELECTRONIC CO., LTD.
Name

8. 適用試験規格: 電気用品の技術上の基準を定める省令の解釈
Applied Standard for Testing Description of the technical requirements by the METI Ordinance
別表第十二 J60691 (H28)

Appendix 12 J60691 (H28)

9. 適合性検査の方法: (Testing Method for Conformity Assessment)

- 1) 試験用の特定電気用品については、電気用品の技術上の基準を定める省令の解釈に定める方法

With respect to testing for Category A products, the testing method is based on the technical requirements of the description of Electrical Appliances and Materials stipulated in the METI Ordinance.

- 2) 当該特定電気用品に係る届出事業者又は事業場における検査設備については、電気用品安全法施行規則別表第四の検査設備の欄に掲げる検査設備ごとにそれぞれ同表の技術上の基準の欄に掲げる方法

With respect to inspection facilities required for Category A products at the factory, Testing Method described in the column of the technical requirements for each inspection facilities in the column of inspection facilities is shown in the Appendix 4 of Enforcement Regulations of the Act.

10. 注意事項

- 1) この適合同等証明書は、提出された試験用の電気用品に関して評価を行った上で交付したものであり、同一の型式の区分にある電気用品について電気用品安全法第8条1項に規定する技術基準適合確認の義務を履行したことを示すものではありません。

This Statement of Conformity Assessment, which is issued on the evaluation of the submitted test-use Electrical Appliances and Materials, does not signify that the Obligation to Comply with Requirements, which is prescribed at Paragraph 1 of Article 8 of the Act, is fulfilled on Electrical Appliances and Materials in the same Type Classification.

- 2) この適合同等証明書は、別紙に記載されている型式の区分の範囲内及び区分の組み合わせについてのみ有効です。

This Statement of Conformity Assessment is valid only for Electrical Appliances and Materials within the Type Classifications and their combination as stated in the attached "Type Classification".

順海科技
0755-2810001F

一般財団法人 電気安全環境研究所
Japan Electrical Safety & Environment technology Laboratories (JET)

理事長 薦田 康久
President Yasuhisa Komoda

東京都渋谷区代々木5-14-12
(5-14-12, Yoyogi, Shibuya-ku, Tokyo, Japan)

証明書番号：JET2179-32001-2007

適合同等証明書別紙

Statement of Conformity Assessment

型式の区分

Type Classification

要素 Factor	区分 Classification
定格電圧 Rated voltage	(2) 125Vを超えるもの Exceeding 125V
定格電流 Rated current	(2) 5Aを超え15A以下のもの Exceeding 5A, and less than or equal to 15A
公称動作温度 Nominal operating temperature	(5) 140°Cを超え160°C以下のもの Exceeding 140°C, and less than or equal to 160°C
可溶体への通電 Current to fuse element	(2) ないもの No
可溶体の主材料 Fuse element materials	(3) 合成樹脂又は有機化合物のもの Plastic or organic compound
容器 Container	(1) あるもの With container
端子 Terminals	(2) 線付きのもの Wire lead
可溶体の形状 Shape of fuse element	(2) 塊状のもの Block

順海科技
0755-2810001F

適合同等証明書

Statement of Conformity Assessment

電気用品安全法第8条第1項に規定する技術基準及び同法第9条第2項の経済産業省令で定める基準（法第9条第1項第2号に係る検査に係るものに限る）に適合していることを証明します

I hereby certify that the product mentioned below complies with the technical requirements stipulated in Paragraph 1 of Article 8 of Electrical Appliances and Materials Safety Act (here under referred to as the Act) and the requirements defined by the ordinance of the Ministry of Economy, Trade and Industry based on Paragraph 2 of Article 9 of the Act (limited to Item 2 of Paragraph 1 of Article 9 for Inspection of the Act).

1. 証明書番号: JET2179-32001-2008
Statement Number
2. 交付年月日: 2019年6月26日
Effective Date June 26, 2019
3. 有効年月日: 2026年6月25日
Date of Validity June 25, 2026
4. 申込者名 (Applicant)
住所 (Address): FENHU TECHNIC DEVELOPMENT ZONE WUJIANG, JIANGSU PROVINCE, CHINA

氏名又は名称: SUZHOU WALTER ELECTRONIC CO., LTD.
Name

5. 特定電気用品名: 温度ヒューズ
Name of Product Thermal links
6. 型式の区分: 別紙のとおり
Type Classification See attached "Type Classification"
7. 製造工場名 (Manufacturer)
住所 (Address): FENHU TECHNIC DEVELOPMENT ZONE WUJIANG, JIANGSU PROVINCE, CHINA

氏名又は名称: SUZHOU WALTER ELECTRONIC CO., LTD.
Name

8. 適用試験規格: 電気用品の技術上の基準を定める省令の解釈
Applied Standard for Testing Description of the technical requirements by the METI Ordinance
別表第十二 J60691 (H28)

Appendix 12 J60691 (H28)

9. 適合性検査の方法: (Testing Method for Conformity Assessment)

- 1) 試験用の特定電気用品については、電気用品の技術上の基準を定める省令の解釈に定める方法

With respect to testing for Category A products, the testing method is based on the technical requirements of the description of Electrical Appliances and Materials stipulated in the METI Ordinance.

- 2) 当該特定電気用品に係る届出事業者又は事業場における検査設備については、電気用品安全法施行規則別表第四の検査設備の欄に掲げる検査設備ごとにそれぞれ同表の技術上の基準の欄に掲げる方法

With respect to inspection facilities required for Category A products at the factory, Testing Method described in the column of the technical requirements for each inspection facilities in the column of inspection facilities is shown in the Appendix 4 of Enforcement Regulations of the Act.

10. 注意事項

- 1) この適合同等証明書は、提出された試験用の電気用品に関して評価を行った上で交付したものであり、同一の型式の区分にある電気用品について電気用品安全法第8条1項に規定する技術基準適合確認の義務を履行したことを示すものではありません。

This Statement of Conformity Assessment, which is issued on the evaluation of the submitted test-use Electrical Appliances and Materials, does not signify that the Obligation to Comply with Requirements, which is prescribed at Paragraph 1 of Article 8 of the Act, is fulfilled on Electrical Appliances and Materials in the same Type Classification.

- 2) この適合同等証明書は、別紙に記載されている型式の区分の範囲内及び区分の組み合わせについてのみ有効です。

This Statement of Conformity Assessment is valid only for Electrical Appliances and Materials within the Type Classifications and their combination as stated in the attached "Type Classification".

順海科技
0755-28100016

一般財団法人 電気安全環境研究所
Japan Electrical Safety & Environment technology Laboratories (JET)

理事長 薦田 康久
President Yasuhisa Komoda

東京都渋谷区代々木5-14-12
(5-14-12, Yoyogi, Shibuya-ku, Tokyo, Japan)

証明書番号 : J E T 2 1 7 9 - 3 2 0 0 1 - 2 0 0 8

適合同等証明書別紙

Statement of Conformity Assessment

型式の区分

Type Classification

要素 Factor	区分 Classification
定格電圧 Rated voltage	(2) 125Vを超えるもの Exceeding 125V
定格電流 Rated current	(2) 5Aを超え15A以下のもの Exceeding 5A, and less than or equal to 15A
公称動作温度 Nominal operating temperature	(8) 200℃を超え220℃以下のもの Exceeding 200℃, and less than or equal to 220℃
可溶体への通電 Current to fuse element	(2) ないもの No
可溶体の主材料 Fuse element materials	(3) 合成樹脂又は有機化合物のもの Plastic or organic compound
容器 Container	(1) あるもの With container
端子 Terminals	(2) 線付きのもの Wire lead
可溶体の形状 Shape of fuse element	(2) 塊状のもの Block

順海科技
0755-28100016

適合同等証明書

Statement of Conformity Assessment

電気用品安全法第8条第1項に規定する技術基準及び同法第9条第2項の経済産業省令で定める基準（法第9条第1項第2号に係る検査に係るものに限る）に適合していることを証明します

I hereby certify that the product mentioned below complies with the technical requirements stipulated in Paragraph 1 of Article 8 of Electrical Appliances and Materials Safety Act (here under referred to as the Act) and the requirements defined by the ordinance of the Ministry of Economy, Trade and Industry based on Paragraph 2 of Article 9 of the Act (limited to Item 2 of Paragraph 1 of Article 9 for Inspection of the Act).

1. 証明書番号: JET 2179-32001-2009
Statement Number
2. 交付年月日: 2019年6月26日
Effective Date June 26, 2019
3. 有効年月日: 2026年6月25日
Date of Validity June 25, 2026
4. 申込者名 (Applicant)
住所: FENHU TECHNIC DEVELOPMENT ZONE WUJIANG, JIANGSU PROVINCE, CHINA
Address

氏名又は名称: SUZHOU WALTER ELECTRONIC CO., LTD.
Name

5. 特定電気用品名: 温度ヒューズ
Name of Product Thermal links
6. 型式の区分: 別紙のとおり
Type Classification See attached "Type Classification"
7. 製造工場名 (Manufacturer)
住所: FENHU TECHNIC DEVELOPMENT ZONE WUJIANG, JIANGSU PROVINCE, CHINA
Address

氏名又は名称: SUZHOU WALTER ELECTRONIC CO., LTD.
Name

8. 適用試験規格: 電気用品の技術上の基準を定める省令の解釈
Applied Standard for Testing Description of the technical requirements by the METI Ordinance
別表第十二 J60691 (H28)

Appendix 12 J60691 (H28)

9. 適合性検査の方法: (Testing Method for Conformity Assessment)

- 1) 試験用の特定電気用品については、電気用品の技術上の基準を定める省令の解釈に定める方法

With respect to testing for Category A products, the testing method is based on the technical requirements of the description of Electrical Appliances and Materials stipulated in the METI Ordinance.

- 2) 当該特定電気用品に係る届出事業者又は事業場における検査設備については、電気用品安全法施行規則別表第四の検査設備の欄に掲げる検査設備ごとにそれぞれ同表の技術上の基準の欄に掲げる方法

With respect to inspection facilities required for Category A products at the factory, Testing Method described in the column of the technical requirements for each inspection facilities in the column of inspection facilities is shown in the Appendix 4 of Enforcement Regulations of the Act.

10. 注意事項

- 1) この適合同等証明書は、提出された試験用の電気用品に関して評価を行った上で交付したものであり、同一の型式の区分にある電気用品について電気用品安全法第8条1項に規定する技術基準適合確認の義務を履行したことを示すものではありません。

This Statement of Conformity Assessment, which is issued on the evaluation of the submitted test-use Electrical Appliances and Materials, does not signify that the Obligation to Comply with Requirements, which is prescribed at Paragraph 1 of Article 8 of the Act, is fulfilled on Electrical Appliances and Materials in the same Type Classification.

- 2) この適合同等証明書は、別紙に記載されている型式の区分の範囲内及び区分の組み合わせについてのみ有効です。

This Statement of Conformity Assessment is valid only for Electrical Appliances and Materials within the Type Classifications and their combination as stated in the attached "Type Classification".

順海科技
0755-2810001F

一般財団法人 電気安全環境研究所
Japan Electrical Safety & Environment technology Laboratories (JET)

理事長 薦田 康久
President Yasuhisa Komoda

東京都渋谷区代々木5-14-12
(5-14-12, Yoyogi, Shibuya-ku, Tokyo, Japan)

証明書番号：JET2179-32001-2009

適合同等証明書別紙

Statement of Conformity Assessment

型式の区分

Type Classification

要素 Factor	区分 Classification
定格電圧 Rated voltage	(2) 125Vを超えるもの Exceeding 125V
定格電流 Rated current	(2) 5Aを超え15A以下のもの Exceeding 5A, and less than or equal to 15A
公称動作温度 Nominal operating temperature	(2) 80°Cを超え100°C以下のもの Exceeding 80°C, and less than or equal to 100°C
可溶体への通電 Current to fuse element	(2) ないもの No
可溶体の主材料 Fuse element materials	(3) 合成樹脂又は有機化合物のもの Plastic or organic compound
容器 Container	(1) あるもの With container
端子 Terminals	(2) 線付きのもの Wire lead
可溶体の形状 Shape of fuse element	(2) 塊状のもの Block

順海科技
0755-28100015