

1. 適用範圍/SCOPE

2010 系列保險絲 · 適用於一般電子設備。
2010 series Fuse, used in electronic equipment.

2. 產品型號/TYPE

例「example」：



- ① 系列號 / Series Number
- ② 延時性 T / Time-Lag Type
- ③ 額定電流 / Rated Current
- ④ 額定電壓 / Rated Voltage
- ⑤ 認證符號 / Approved Symbol

3. 額定電流和額定電壓 / RATED CURRENT AND RATED VOLTAGE

額定電流 / Rated Current:

100mA~10A

額定電壓 / Rated Voltage :

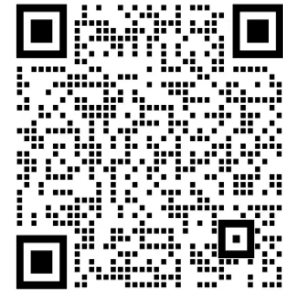

250V AC







4. 標示/MARKING

保險絲上需有下列標示 / The fuses shall have the following marking:

- ① 製造工廠及品名的標識 / Manufacturer's Logo and product name:  2010
- ② 電氣特性 / Electrical Characteristic: T (延時性的保險絲符號 symbol for Time-Lag)
- ③ 額定電流 / Rated Current (A): ___A 或 ___mA
- ④ 額定電壓 / Rated Voltage (V): 250V
- ⑤ 認證符號 / Approval Marks:

100mA~800mA   

1A~6.3A :    

8A~10A :    

5. 外觀及形狀/APPEARANCES AND CONFIGURATION

5-1 外觀不應有顯著的汙點、鐵銹或裂紋; 標示應該容易辨識。

There shall not be any remarkable stain, rust or crack on the appearances;
marking shall be easily legible.

5-2 形狀：帶直線引腳的超小型保險絲。

Configuration : Radial leaded Sub-Miniature Fuse.

6. 工程圖和結構/OUTLINE DRAWING AND STRUCTURE

6-1 工程圖 (單位 : mm) / Outline Drawing and Dimensions (Unit: mm)

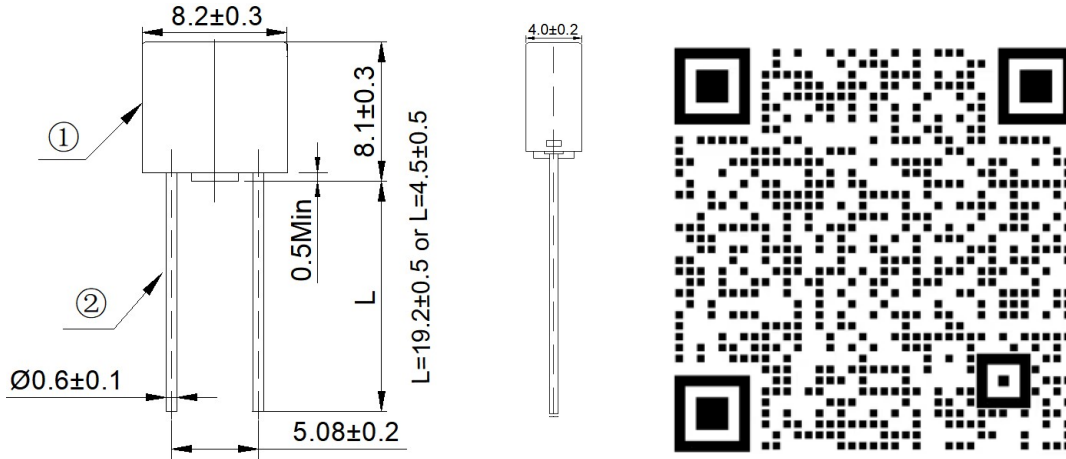

6-2 結構 / Structure

編號 No.	元件 Component	材質 Material	數量 Quantity
1	本體 Body	耐熱性塑膠 Polyamide66 Thermoplastic,UL-94-Vo	1
2	端子 Termination	鍍錫銅線 Tin Plated Copper	2

7. 產品特性/PRODUCT CHARACTERISTICS

7-1 引腳拉力強度 / Lead Pull Strength

10 牛頓 10±1 秒 / 10N for 10±1 Seconds

7-2 引腳推力強度 / Lead Thrust Strength

2 牛頓 10±1 秒 / 2N for 10±1 Seconds

7-3 可焊性 / Solderability

波峰焊/Wave : 260°C · ≤3s;

烙鐵焊/Soldering Iron: 350±10°C · ≤1s.

7-4 耐焊接熱 / Soldering Heat Resistance

波峰焊/Wave : 260°C · 10s;

烙鐵焊/Soldering Iron: 350°C · 3s.

8. 電氣特性/ELECTRICAL CHARACTERISTICS

8-1 熔斷 / 電流特性 : Pre-Arcing Time / Current Characteristic (limits) 延遲性保險絲 Time-Lag Type

RATED CURRENT	2.1 IN	2.75 IN		4 IN		10 IN	
100mA~10A	Max.	Min.	Max.	Min.	Max.	Min.	Max.
	2min	400ms	10s	150ms	3s	20ms	150ms

8-2 產品規格/Specification

額定電流 Rated Current	冷電阻 Cold resistance	最大電壓降 Max Voltage Drop (mV)	最大功耗 Max Power Dissipation (mW)	I ² T 值 I ² T Value (A ² Sec@10In)
100mA	2.60Ω	350	170	0.075
125mA	1.75Ω	300	180	0.11
160mA	1.25Ω	280	190	0.17
200mA	0.90Ω	260	200	0.3
250mA	0.63Ω	240	220	0.71
315mA	0.53Ω	220	250	1.0
400mA	0.34Ω	200	280	1.5
500mA	0.24Ω	190	310	2.9
630mA	0.17Ω	180	360	4.3
800mA	0.12Ω	160	430	6.5
1A	89.50mΩ	140	500	11
1.25A	62.75mΩ	130	600	15
1.6A	44.25mΩ	120	730	26
2A	34.50mΩ	100	870	37
2.5A	24.25mΩ	100	1000	61
3.15A	18.25mΩ	100	1200	98
4A	12.50mΩ	100	1400	136
5A	9.25mΩ	100	1500	212
6.3A	6.50mΩ	100	1650	321
8A	5.50mΩ	80	1800	360
10A	4.50mΩ	75	2000	405

8-3 分斷能力/Breaking Capacity

UL	100mA~10A	130A/250V AC
VDE	100mA~6.3A	100A/250V AC
	3.15A~6.3A	130A/250V AC
TUV	8A~10A	130A/250V AC
CCC	100mA~10A	130A/250V AC
PSE	1A~10A	100A/250V AC
SEMKO	100mA~6.3A	100A/250V AC
KC	100mA~6.3A	130A/250V AC

8-4 時間電流曲線/Time-Current Curve

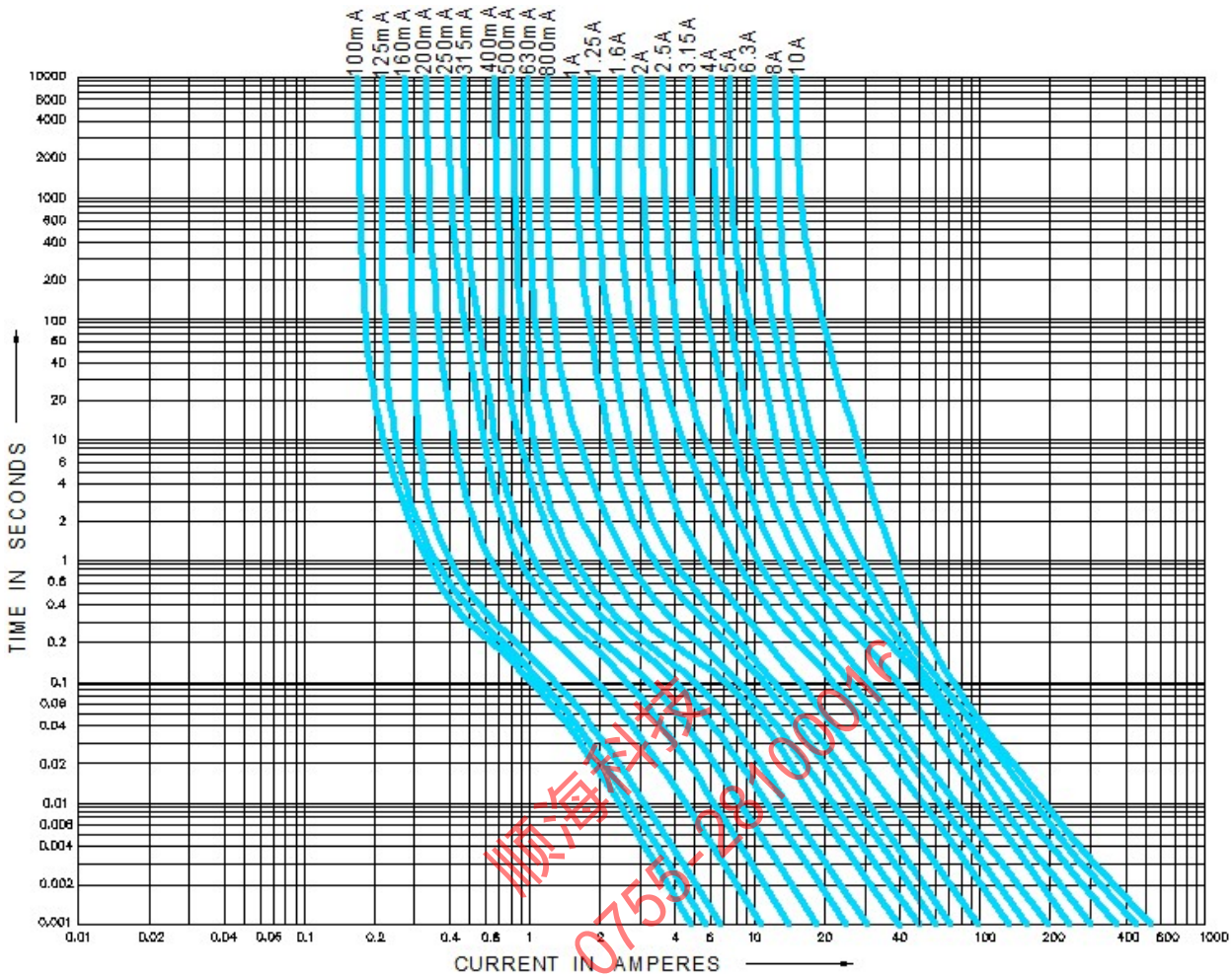

9. 環境特性/ENVIRONMENTAL CHARACTERISTIC

9-1 操作溫度範圍: -55°C ~ 125°C / Operating Temperature:-55°C ~ 125°C

若貴司操作環境溫度超出25±5°C範圍，在選用保險絲規格時，需考慮操作環境溫度對保險絲的影響。
請參照：溫度-電流曲線圖。

When choosing the fuse's specification, if the operating environmental temperature beyond the scope from 20~30°C, you should consider the environmental temperature's affection to fuses.
please refer:

Temperature-Cur1rent curve:

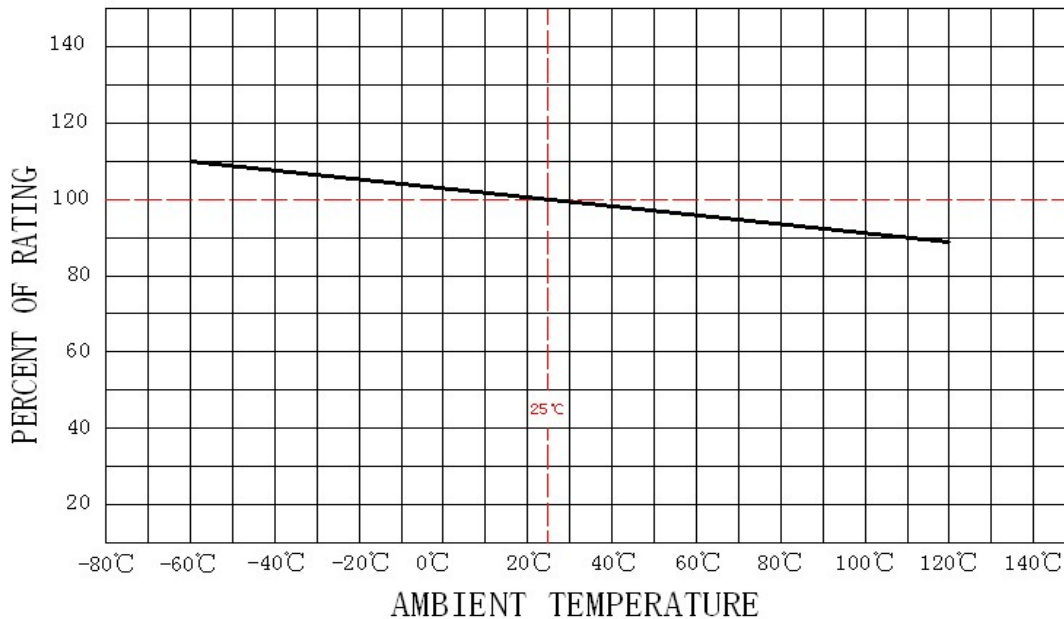

9-2 存儲條件/Storage Conditions

在溫度+10°C ~ 60°C、相對濕度 $\leq 75\%$ 的密閉條件下可存放 3 年。

Under airtight in temperature+10°C ~ 60°C、relative humidity $\leq 75\%$ can store 3 years.

在溫度+10°C ~ 60°C、相對濕度為 95%的非露天下最多可存放 30 天。

Without dew in temperature+10°C ~ 60°C、relative humidity be 95% maximum value for 30 days.

10. 安裝方式及條件/INSTALLATION WAY AND PARAMETERS

10-1 建議如下圖安裝方式安裝，並滿足所要求的尺寸。

Propose that the following picture installation way is installed, and satisfied the required size.

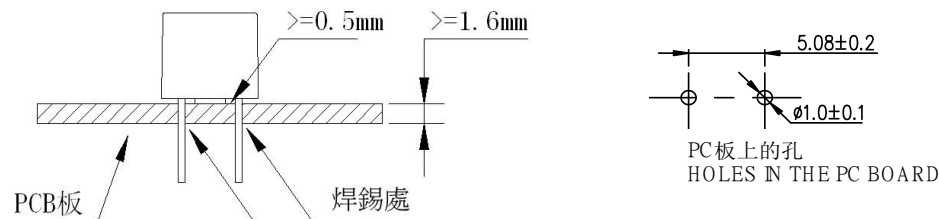

10-2 建議客戶焊接參數 / Recommended Customer Soldering Parameters

波峰焊參數 / Wave Parameters

錫爐溫度 / Solder Pot Temperature: 260°C Max

焊接時間 / Solder Dwell Time: 2~5s

手工焊參數 / Hand-Solder Parameters

烙鐵溫度 / Solder Iron Temperature: 350 \pm 5°C

焊接時間 / Heating Time: 1~2 s Max

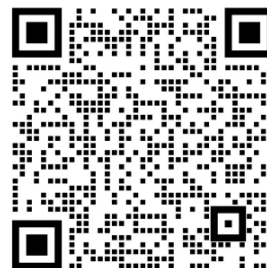

11. 其他使用注意事項/OTHER NOTICE IN USED

符合本公司可能的其他檔的要求/ It could be in conformance with another file, which made by our company.

12. 安全認證及編號/STANDARDS AND APPROVALS

UL	E56092 (100mA~10A)
VDE	40018781 (100mA~6.3A)
TUV	J50361151 (8A~10A)
SEMKO	SE-S-2001851 (100mA~6.3A)
PSE	JET2179-31007-1002 (1A~5A) 、JET2179-31007-1001 (6.3A~10A)
CCC	2020970207000232 (100mA~10A)
KC	SU05015-12007 (100mA) 、SU05015-12006 (125mA~800mA) SU05015-12008 (1A~2.5A) 、SU05015-12002 (3.15A~6.3A)

13. 包裝/PACKING

13-1 編帶包裝/Taping package

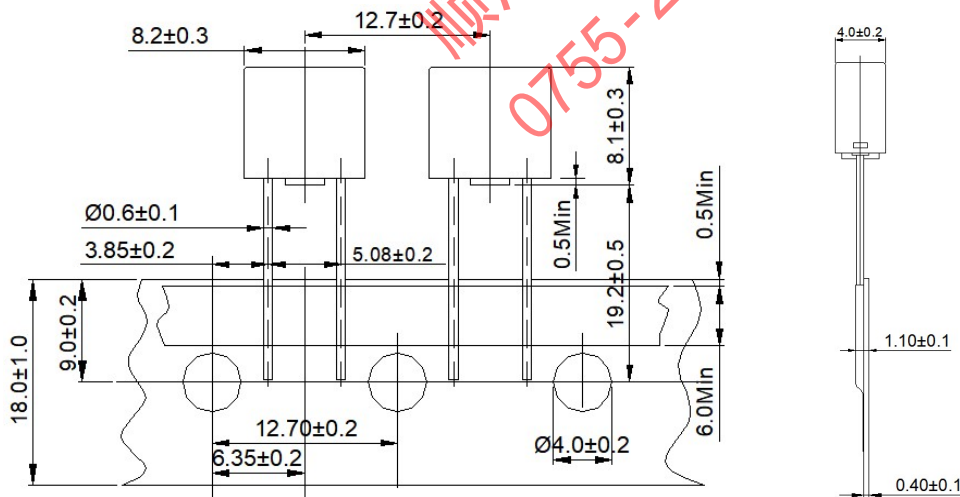

13-1-2 包裝數量 / Packing Quantity

A:每盒 1000 個保險絲/1000 pcs per box.

B:每外箱裝 10 內盒保險絲 /10 inner boxes per outer box.

13-1-3 內包裝盒/Inner box of packing

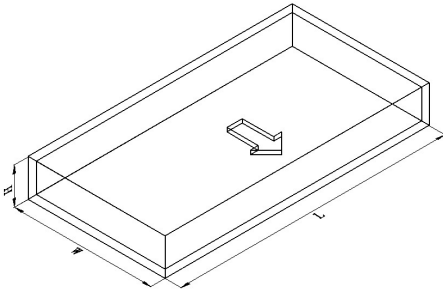

單位/Unit:mm

L	W	H
330±3	175±3	40±3

13-1-4 外包裝箱/Outer box of packing

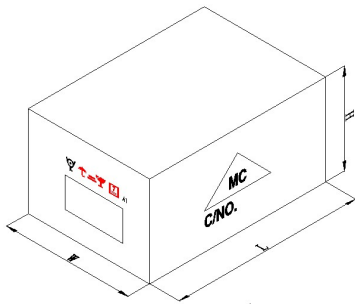

單位/Unit:mm

L	W	H
440±5	345±5	205±5

順海科技
0755-28100016

13-2 散裝包裝/Bulk package

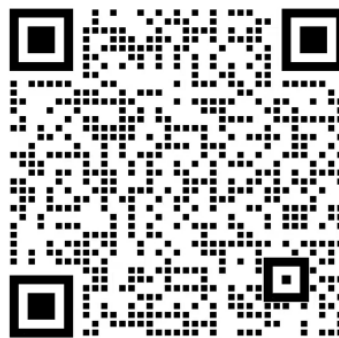
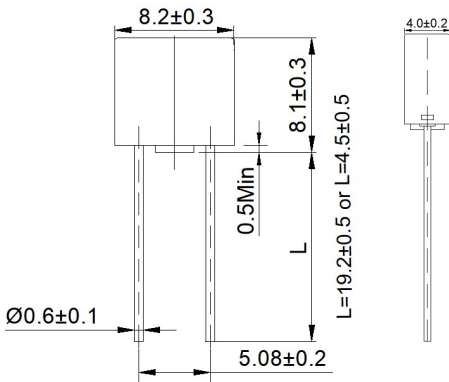

13-2-1 包裝數量 / Packing Quantity

A:散裝每膠袋 1000 個保險絲 /Bulk 1000 pcs/ poly bag

B:每盒 2 袋共 2000 個保險絲 / 2 poly bags / box, altogether 2000 pcs.

C:每外箱裝 5 內盒保險絲/5 inner boxes per outer box .

13-2-2 內膠袋 In plastic bags



單位/Unit:mm

L	W	H
254±5	178±3	0.04

13-2-3 內包裝盒/Inner box of packing

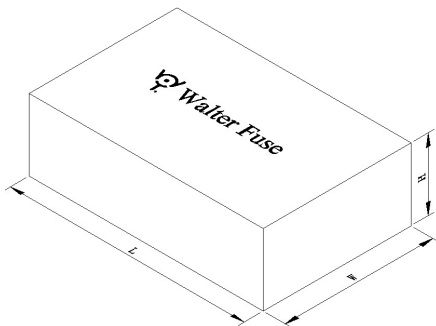

單位/Unit:mm

L	W	H
245±3	155±3	75±2

13-2-4 外包裝箱/Outer box of packing

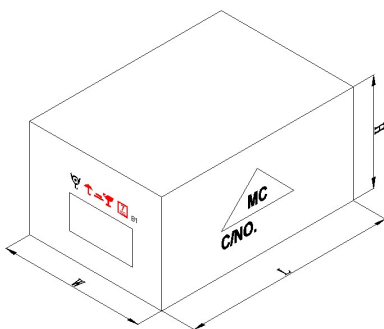

單位/Unit:mm

L	W	H
430±5	270±5	180±5

順海科技
0755-28100016

14. 其他/OTHERS

14-1 如果在使用中有超出本規格書的要求，必須經由雙方協商確認。

In the event that an impropriety is found beyond this specification ,it shall be fixed by mutual agreement between the parties.

14-2 如果本規格書有不適當的情況，必須通過雙方協商並由本公司修改。

In the event that an impropriety is found in this specification , SUZHOU WALTER ELECTRONIC CO., LTD. shall amend it by mutual agreement between the parties.

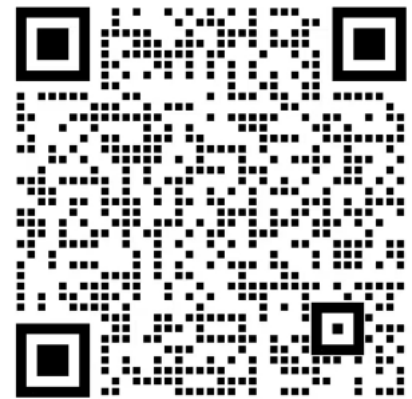

順海科技
0755-28100016

版次	製作	確認	審核
第22版	程正永 2021/09/09	饒紅 2021/09/09	Russel.Hsu 2021/9/9



UL iQ for Fuses



Fuses

E56092

Guide Information

SUZHOU WALTER ELECTRONIC CO LTD

NO.99 Xinli Road, Fenhu Technic Development Zone, Wujiang Jiangsu 215211 CN

2010

Supplemental micro fuses: pigtail leads

<u>Size</u> mm(in)	<u>Amps</u> (A)	<u>Volts</u> (V)	<u>Interrupting</u> <u>Rating (A)</u>
8.4 x 4.1 x 8.4 (0.33 x 0.16 x 0.33)	0.1 - 10	250Vac	130
	0.1 - 6.3	300Vac	50
	8 - 10	300Vac	100

Report Date: 2004-05-07

Last Revised: 2019-07-22

© 2019 UL LLC



顺海科技
0755-28100016

GUTACHTEN MIT FERTIGUNGSÜBERWACHUNG CERTIFICATE OF CONFORMITY WITH FACTORY SURVEILLANCE

Suzhou Walter Electronic
Co. Ltd.
Fenhu Technic Development Zone
215211 Luxu Town, Wujiang City
Jiangsu
China

ist berechtigt, für ihr Produkt /
is authorized to use for their product

Kleinstsicherungseinsatz
Sub-miniature fuse-link

die hier abgebildeten markenrechtlich geschützten Zeichen
für die ab Blatt 2 aufgeführten Typen zu benutzen /
the legally protected Marks as shown below for the types referred to on page 2 ff.



REG B936 oder/or



oder/or VDE-REG B936

REG B936

Geprüft und zertifiziert nach /
Tested and certified according to

DIN EN 60127-1 (VDE 0820-1):2015-12; EN 60127-1:2006+A1:2011+A2:2015
DIN EN 60127-3 (VDE 0820-3):2015-11; EN 60127-3:2015
IEC 60127-1:2006
IEC 60127-1:2006/AMD1:2011
IEC 60127-1:2006/AMD2:2015
IEC 60127-3:2015



Aktenzeichen: 5000410-1170-0023 / 274200

File ref.:

Ausweis-Nr. 40018781

Blatt 1

Certificate No.

Page

Weitere Bedingungen siehe Rückseite und Folgeblätter /
further conditions see overleaf and following pages

Offenbach, 2006-09-05

(letzte Änderung / updated 2020-07-16)

VDE Prüf- und Zertifizierungsinstitut GmbH
VDE Testing and Certification Institute
Zertifizierungsstelle / Certification

M. Tasotti

VDE Zertifikate sind nur gültig bei Veröffentlichung unter:
VDE certificates are valid only when published on:

<http://www.vde.com/zertifikat>
<http://www.vde.com/certificate>

Name und Sitz des Genehmigungs-Inhabers / Name and registered seat of the Certificate holder

Suzhou Walter Electronic Co. Ltd., Fenu Technic Development Zone, 215211 LUXU TOWN, WUJIANG CITY,
Jiangsu, CHINA

Aktenzeichen / File ref.

5000410-1170-0023 / 274200 / TL3 / EUL

letzte Änderung / updated

2020-07-16

Datum / Date

2006-09-05

Dieses Blatt gilt nur in Verbindung mit Blatt 1 des Gutachtens mit Fertigungsüberwachung Nr. 40018781.

This supplement is only valid in conjunction with page 1 of the Certificate of Conformity with factory surveillance No. 40018781.

Kleinstsicherungseinsatz Sub-miniature fuse-link

Typ(en) / Type(s)

2010 Serie(s)

Bemessungsspannung
Rated voltage

AC 250 V ; AC 300 V

Bemessungsstrom
Rated current

100 mA; 125 mA; 160 mA; 200 mA;
250 mA; 315 mA; 400 mA; 500 mA;
630 mA; 800 mA; 1 A; 1,25 A; 1,6 A;
2 A; 2,5 A; 3,15 A; 4 A; 5 A; 6,3 A

Normblatt
Standard sheet

4

Kennzeichnung der Charakteristik
Characteristic symbol

T

Bemessungsausschaltvermögen
Rated breaking capacity

130 A (AC 250 V; 3,15 A - 6,3 A)
100 A (AC 250 V; 100 mA - 6,3 A)
50 A (AC 300 V; 100 mA - 5 A)
63 A (AC 300 V; 6,3 A)

Zeit/Strom-Charakteristik
Time/current-characteristic

träge
time-lag

Anmerkung
Remark

Die Prüfspannung in Abschnitt 9.2 war DC 63V.
The test Voltage in clause 9.2 was DC 63V.

Fortsetzung siehe Blatt 3 /
continued on page 3

VDE Prüf- und Zertifizierungsinstitut Gutachten mit Fertigungsüberwachung

Ausweis-Nr. / Blatt /
Certificate No. / Page
40018781 3

Name und Sitz des Genehmigungs-Inhabers / *Name and registered seat of the Certificate holder*

Suzhou Walter Electronic Co. Ltd., Fenu Technic Development Zone, 215211 LUXU TOWN, WUJIANG CITY,
Jiangsu, CHINA

Aktenzeichen / *File ref.*

5000410-1170-0023 / 274200 / TL3 / EUL

letzte Änderung / *updated*

2020-07-16

Datum / *Date*

2006-09-05

Dieses Blatt gilt nur in Verbindung mit Blatt 1 des Gutachtens mit Fertigungsüberwachung Nr. 40018781.

This supplement is only valid in conjunction with page 1 of the Certificate of Conformity with factory surveillance No. 40018781.

Ausführung(en)
Construction(s)

Rechteckige Bauform
Rectangular shape

Dieser Zeichengenehmigungs-Ausweis bildet eine Grundlage für die EG-Konformitätserklärung und CE-Kennzeichnung durch den Hersteller oder dessen Bevollmächtigten und bescheinigt die Konformität mit den grundlegenden Schutzanforderungen der **EG-Niederspannungsrichtlinie 2014/35/EU**.

*This Marks Approval is a basis for the EC Declaration of Conformity and the CE Marking by the manufacturer or his agent and proves the conformity with the essential safety requirements of the **EC Low-Voltage Directive 2014/35/EU**.*

VDE Prüf- und Zertifizierungsinstitut GmbH
VDE Testing and Certification Institute
Fachgebiet TL3
Section TL3

顺海科技
0755-28100016

VDE Prüf- und Zertifizierungsinstitut Gutachten mit Fertigungsüberwachung

Ausweis-Nr. / Beiblatt /
Certificate No. Supplement
40018781

Name und Sitz des Genehmigungs-Inhabers / *Name and registered seat of the Certificate holder*

Suzhou Walter Electronic Co. Ltd., Fenu Technic Development Zone, 215211 LUXU TOWN, WUJIANG CITY,
Jiangsu, CHINA

Aktenzeichen / *File ref.*

5000410-1170-0023 / 274200 / TL3 / EUL

letzte Änderung / *updated*

2020-07-16

Datum / *Date*

2006-09-05

Dieses Beiblatt ist Bestandteil des Gutachtens mit Fertigungsüberwachung Nr. 40018781.

This supplement is part of the Certificate of Conformity with factory surveillance No. 40018781.

Kleinstsicherungseinsatz *Sub-miniature fuse-link*

Fertigungsstätte(n)

Place(s) of manufacture

Referenz/*Reference*
30011941

Suzhou Walter Electronic
Co. Ltd.
Fenu Technic Development Zone
215211 LUXU TOWN, WUJIANG CITY
Jiangsu
CHINA

VDE Prüf- und Zertifizierungsinstitut GmbH
VDE Testing and Certification Institute
Fachgebiet TL3
Section TL3

VDE Prüf- und Zertifizierungsinstitut Gutachten mit Fertigungsüberwachung

Ausweis-Nr. / Infoblatt /
Certificate No. / Info sheet
40018781

Name und Sitz des Genehmigungs-Inhabers / Name and registered seat of the Certificate holder

Suzhou Walter Electronic Co. Ltd., Fenuh Technic Development Zone, 215211 LUXU TOWN, WUJIANG CITY, Jiangsu, CHINA

Aktenzeichen / File ref.

5000410-1170-0023 / 274200 / TL3 / EUL

letzte Änderung / updated

2020-07-16

Datum / Date

2006-09-05

Dieses Blatt gilt nur in Verbindung mit Blatt 1 des Gutachtens mit Fertigungsüberwachung Nr. 40018781.

This supplement is only valid in conjunction with page 1 of the Certificate of Conformity with factory surveillance No. 40018781.

Genehmigung zum Benutzen des auf Seite 1 abgebildeten markenrechtlich geschützten Zeichens des VDE:

Grundlage für die Benutzung sind die Allgemeinen Geschäftsbedingungen (AGB) der VDE Prüf- und Zertifizierungsinstitut GmbH (www.vde.com\AGB-Institut). Das Recht zur Benutzung erstreckt sich nur auf die bezeichnete Firma mit den genannten Fertigungsstätten und die oben aufgeführten Produkte mit den zugeordneten Bezeichnungen. Die Fertigungsstätte muss so eingerichtet sein, dass eine gleichmäßige Herstellung der geprüften und zertifizierten Ausführung gewährleistet ist.

Die Genehmigung ist so lange gültig wie die VDE-Bestimmungen gelten, die der Zertifizierung zugrunde gelegen haben, sofern sie nicht auf Grund anderer Bedingungen aus der VDE Prüf- und Zertifizierungsordnung (PM102) zurückgezogen werden muss.

Der Gültigkeitszeitraum einer VDE-GS-Zeichengenehmigung kann auf Antrag verlängert werden. Bei gesetzlichen und / oder normativen Änderungen kann die VDE-GS-Zeichengenehmigung ihre Gültigkeit zu einem früheren als dem angegebenen Datum verlieren.

Produkte, die das Biozid Dimethylfumarat (DMF) enthalten, dürfen gemäß der Kommissionsentscheidung 2009/251/EG nicht mehr in den Verkehr gebracht oder auf dem Markt bereitgestellt werden.

Der VDE-Zeichengenehmigungsausweis wird ausschließlich auf der ersten Seite unterzeichnet.

Approval to use the legally protected Mark of the VDE as shown on the first page:

Basis for the use are the general terms and conditions of the VDE Testing and Certification Institute (www.vde.com\terms-institute). The right to use the mark is granted only to the mentioned company with the named places of manufacture and the listed products with the related type references. The place of manufacture shall be equipped in a way that a constant manufacturing of the certified construction is assured.

The approval is valid as long as the VDE specifications are in force, on which the certification is based on, unless it is withdrawn according to the VDE Testing and Certification Procedure (PM102E).

The validity period of a VDE-GS-Mark Approval may be prolonged on request. In case of changes in legal and / or normative requirements, the validity period of a VDE-GS-Mark Approval may be shortened.

Products containing the biocide dimethylfumarate (DMF) may not be marketed or made available on the EC market according to the Commission Decision 2009/251/EC.

The approval is solely signed on the first page.

强制性认证产品符合性自我声明



自我声明编号: 2020970207000232

苏州华德电子有限公司(生产者) 确认知晓《强制性产品认证自我声明实施规则》以及相关产品强制性认证实施规则的要求, 对本声明承担全部法律责任。

苏州华德电子有限公司(生产者) 声明以下产品已按照《强制性产品认证自我声明实施规则》以及相关产品强制性认证实施规则的要求进行检测, 符合相关标准要求; 自本声明签署之日起, 生产和销售的产品持续符合以下标准与实施规则的要求; 保存本声明涉及的技术文档至少10年; 正确使用强制性产品认证标志; 如产品或其符合性信息发生变更, 将及时更新技术文档并报送产品变更信息。

生产者名称: 苏州华德电子有限公司
生产者地址: 江苏省苏州市吴江区汾湖经济技术开发区(芦墟)
依据的强制性产品认证规则: CNCA-00C-008: 2019 强制性产品认证实施规则自我声明
产品名称: 超小型熔断体
产品系列、型号、规格: 见附件
依据的标准: GB/T9364.3-2018; GB/T9364.1-2015
生产企业名称: 苏州华德电子有限公司
生产企业地址: 江苏省吴江汾湖经济开发区新黎路99号

顺海科技
0755-28100016

联系人: 杜技伟
电话: 0769-87772561 (Ext. 134)
电子邮箱: td.chiang@walterfuse.com
指定签字人:

杜技伟

自我声明时间: 2020-08-31

自我声明地点: 苏州

生产者签章:

程



注: 有关本声明信息真伪可登录全国认证认可信息公共服务平台 (cx.cnca.cn) 或扫描右上角二维码查询。

附 录

证书编号：2020970207000232

第 1 页 共 1 页

纸 号：

产品名称：超小型熔断体

型号：2010 T100mA250V AC、2010 T125mA250V AC、
2010 T160mA250V AC、2010 T200mA250V AC、
2010 T250mA250V AC、2010 T315mA250V AC、
2010 T400mA250V AC、2010 T500mA250V AC、
2010 T630mA250V AC、2010 T800mA250V AC、
2010 T1A250V AC、2010 T1.25A250V AC、
2010 T1.6A250V AC、2010 T2A250V AC、
2010 T2.5A250V AC、2010 T3.15A250V AC、
2010 T4A250V AC、2010 T5A250V AC、
2010 T6.3A250V AC、2010 T8A250V AC、
2010 T10A250V AC

顺海科技
0755-28100016

注：此附录与证书同时使用时有效。

CERTIFICATE

FOR EUROPEAN PRODUCT SAFETY

Reference No. SE-S-2001851

Sub-miniature fuse-link

Type designation: 2010

Certificate holder: Suzhou Walter Electronic Co., Ltd.
Fenhu Technic Development Zone
Wujiang, Jiangsu
CHINA

The product complies with the standard(s): EN 60127-3:2015

Date of expiry: 12 December, 2024

EU Directive information: According to the principle of presumption of conformity, this certificate constitutes support for an EC Declaration of Conformity and CE marking according to the Low Voltage Directive 2014/35/EU.

Additional information in Appendix

Certification Body: Intertek Semko AB, Product Certification **Place:** Kista - Stockholm

Signed:  **Date:** 30 June, 2020

Leif Söderlund

APPENDIX:

Reference No. SE-S-2001851

Technical Data:

Type designation 2010
Rated voltage (V) 250V AC
Rated current (A) 100mA; 125mA; 160mA; 200mA; 250mA; 315mA; 400mA; 500mA; 630mA;
800mA; 1A; 1.25A; 1.6A; 2A; 2.5A; 3.15A; 4A; 5A; 6.3A
Standard sheet 4
Trademark

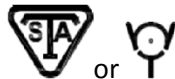

Test Report 1917011STO-001, 2020041STO-003, 1917011STO-002, 2020041STO-004
Product information Time-lag, low-breaking capacity. Rectangular shape. Rated breaking capacity:
100A.

Manufacturing Sites:

Suzhou Walter Electronic Co., Ltd.
Fenhu Technic Development Zone
Wujiang, Jiangsu
China

According to the principle of presumption of conformity, this certificate, which includes production control, constitutes support for an EC Declaration of Conformity and CE marking according to the Low Voltage Directive 2014/35/EU.

This presumption can expire before the end of validity of this certificate due to new issued Standard or Amendment and changes within the EU legislation.

This certificate replaces previously issued ref. No. 1917011 dated 12 December 2019.
A new certificate has been issued due to removal of factory.

Certification Body: Intertek Semko AB, Product Certification **Place:** Kista - Stockholm

Signed:

Date: 30 June, 2020

Leif Söderlund

Zertifikat
mit überwachter Konformität

Certificate
of surveyed conformity



Zertifikat Nr. *Certificate No.*
J 50361151

Blatt *Page*
0001

Ihr Zeichen *Client Reference* Unser Zeichen *Our Reference* Ausstellungsdatum *Date of Issue*
05-ZHANGVIVI-50049138 001 26.10.2016 (day/mo/yr)

Genehmigungsinhaber *License Holder* Fertigungsstätte *Manufacturing Plant*
Walter Electronic Co., Ltd. Dongguan Walter Electric Co., Ltd.
2nd FL. 97 Chung King N RD., Sec. 4 Yantian Village, Fenggang Town
Taipei Dongguan, Guangdong 523702
Taiwan P.R. China

Prüfzeichen *Test Mark*

Geprüft nach *Tested acc. to*



EN 60127-1:2006+A1+A2
EN 60127-3:2015

Zertifiziertes Produkt (Geräteidentifikation)
Certified Product (Product Identification)

Lizenzentgelte - Einheit
License Fee - Unit

(Sub-miniature Fuse)

Type Designation : 2010 6
Trademark : Walter (Logo)
Rated Voltage : AC 250V
Rated Current : 8A; 10A
Rated Breaking Capacity : 130A at 250VAC
100A at 300VAC
T/I Characteristic : T

Remark :

- 1) The requirements of standard sheet 4 were taken into consideration.
- 2) The labelling requirements acc. to EU Directive 2001/95 have to be observed for distribution within the EEA.
- 3) The installation has to be carried out according to installation instruction accompanying the products.

6

ANLAGE (Appendix) : 1

Dem Zertifikat liegt unsere Prüf- und Zertifizierungsordnung zugrunde.
Das Produkt entspricht den o.g. Anforderungen, die Herstellung wird überwacht.
This certificate is based on our Testing and Certification Regulation. The product fulfills above mentioned requirements, the production is subject to surveillance.

TÜV Rheinland LGA Products GmbH, Tillystraße 2, 90431 Nürnberg

Tel.: +49 221 806-1371 e-mail: cert-validity@de.tuv.com
Fax: +49 221 806-3935 http://www.tuv.com/safety



Zertifikat
mit überwachter Konformität

Certificate
of surveyed conformity



Zertifikat Nr. *Certificate No.*
J 50361151

Blatt *Page*
0002

Ihr Zeichen *Client Reference*

Unser Zeichen *Our Reference*

Ausstellungsdatum

Date of issue

05-ZHANGVIVI-50049138 001 26.10.2016 (day/mo/yr)

Genehmigungsinhaber *License Holder*

Walter Electronic Co., Ltd.
2nd FL. 97 Chung King N RD., Sec. 4
Taipei
Taiwan

Fertigungsstätte *Manufacturing Plant*

Suzhou Walter Electronic Co., Ltd.
Fenhu Technic Development Zone, Luxu
Wujiang City, Jiangsu
P.R. China

Prüfzeichen *Test Mark*



Geprüft nach *Tested acc. to*

EN 60127-1:2006+A1+A2
EN 60127-3:2015

Zertifiziertes Produkt (Geräteidentifikation)
Certified Product (Product Identification)

Lizenzentgelte - Einheit
License Fee - Unit

(Sub-miniature Fuse)

As page 0001

Addition

Factory : see above

Remark :

The labelling requirements acc. to EU Directive 2001/95 have to be observed for distribution within the EEA. The installation has to be carried out according to installation instruction accompanying the products.

Dem Zertifikat liegt unsere Prüf- und Zertifizierungsordnung zugrunde.
Das Produkt entspricht den o.g. Anforderungen, die Herstellung wird überwacht.
This certificate is based on our Testing and Certification Regulation. The product fulfills above mentioned requirements, the production is subject to surveillance.

TÜV Rheinland LGA Products GmbH, Tillystraße 2, 90431 Nürnberg

Tel.: +49 221 806-1371 e-mail: cert-validity@de.tuv.com
Fax: +49 221 806-3935 http://www.tuv.com/safety



Zertifikat
mit überwachter Konformität

Certificate
of surveyed conformity



Zertifikat Nr. *Certificate No.*
J 50361151

Blatt *Sheet*
0003

Ihr Zeichen *Client Reference*

Unser Zeichen *Our Reference*

Ausstellungsdatum

Date of Issue

05-YFC-50049138 002

17.07.2018

(day/mo/yr)

Genehmigungsinhaber *License Holder*

Suzhou Walter Electronic Co., Ltd.
Fenhu Technic Development Zone, Luxu
Wujiang City, Jiangsu
P. R. China

Fertigungsstätte *Manufacturing Plant*

Suzhou Walter Electronic Co., Ltd.
Fenhu Technic Development Zone, Luxu
Wujiang City, Jiangsu
P. R. China

Prüfzeichen *Test Mark*



Safety
Regular
Production
Surveillance

www.tuv.com
ID 1419040825

Geprüft nach *Tested acc. to*

EN 60127-1:2006+A1+A2

EN 60127-3:2015

Zertifiziertes Produkt (Geräteidentifikation)
Certified Product (Product Identification)

Lizenzentgelte - Einheit
License Fee - Unit

(Sub-miniature Fuse)

as pages 0001-0002

Change

Name and address of License Holder : see above

Remark :

The labelling requirements acc. to EU Directive
2001/95 have to be observed for distribution within the EEA.
The installation has to be carried out according to
installation instruction accompanying the products.

Dem Zertifikat liegt unsere Prüf- und Zertifizierungsordnung zugrunde.
Das Produkt entspricht den o.g. Anforderungen, die Herstellung wird überwacht.
This certificate is based on our Testing and Certification Regulation. The product
fulfills above mentioned requirements, the production is subject to surveillance.

TÜV Rheinland LGA Products GmbH, Tillystraße 2, 90431 Nürnberg

Tel.: +49 221 806-1371 e-mail: cert-validity@de.tuv.com

Fax: +49 221 806-3935 http://www.tuv.com/safety



顺海科技
0755-28100016

Zertifikat
mit überwachter Konformität

Certificate
of surveyed conformity



Zertifikat Nr. *Certificate No.*
J 50361151

Blatt *Sheet*
0004

Ihr Zeichen <i>Client Reference</i>	Unser Zeichen <i>Our Reference</i>	Ausstellungsdatum <i>Date of Issue</i>	<i>(day/month/year)</i>
	05-YFC-50049138 003	06.09.2018	

Genehmigungsinhaber <i>License Holder</i>	Fertigungsstätte <i>Manufacturing Plant</i>
Suzhou Walter Electronic Co., Ltd. Fenhu Technic Development Zone, Luxu Wujiang City, Jiangsu P. R. China	Dongguan Walter Electric Co., Ltd. Yantian Village, Fenggang Town Dongguan, Guangdong 523702 P. R. China

Prüfzeichen *Test Mark*



Geprüft nach *Tested acc. to*
EN 60127-1:2006+A1+A2
EN 60127-3:2015

Zertifiziertes Produkt (Geräteidentifikation)
Certified Product (Product Identification)

Lizenzentgelte - Einheit
License Fee - Unit

(Sub-miniature Fuse)

as pages 0001-0003

Addition

Rated Voltage : AC 300V

Remark :

The labelling requirements acc. to EU Directive 2001/95 have to be observed for distribution within the EEA. The installation has to be carried out according to installation instruction accompanying the products.

Dem Zertifikat liegt unsere Prüf- und Zertifizierungsordnung zugrunde.
Das Produkt entspricht den o.g. Anforderungen, die Herstellung wird überwacht.
This certificate is based on our Testing and Certification Regulation. The product fulfills above mentioned requirements, the production is subject to surveillance.

TÜV Rheinland LGA Products GmbH, Tillystraße 2, 90431 Nürnberg
Tel.: +49 221 806-1371 e-mail: cert-validity@de.tuv.com
Fax: +49 221 806-3935 http://www.tuv.com/safety



適合同等証明書

Statement of Conformity Assessment

電気用品安全法第8条第1項に規定する技術基準及び同法第9条第2項の経済産業省令で定める基準（法第9条第1項第2号に係る検査に係るものに限る）に適合していることを証明します

I hereby certify that the product mentioned below complies with the technical requirements stipulated in Paragraph 1 of Article 8 of Electrical Appliances and Materials Safety Act (here under referred to as the Act) and the requirements defined by the ordinance of the Ministry of Economy, Trade and Industry based on Paragraph 2 of Article 9 of the Act (limited to Item 2 of Paragraph 1 of Article 9 for Inspection of the Act).

1. 証明書番号: JET 2179-31007-1001
Statement Number
2. 交付年月日: 2019年9月29日
Effective Date September 29, 2019
3. 有効年月日: 2026年9月28日
Date of Validity September 28, 2026
4. 申込者名 (Applicant)
住 所: FENHU TECHNIC DEVELOPMENT ZONE WUJIANG, JIANGSU PROVINCE, CHINA
Address

氏名又は名称: SUZHOU WALTER ELECTRONIC CO., LTD.
Name

5. 特定電気用品名: その他の包装ヒューズ
Name of Product Other enclosed fuses
6. 型式の区分: 別紙のとおり
Type Classification See attached "Type Classification"
7. 製造工場名 (Manufacturer)
住 所: FENHU TECHNIC DEVELOPMENT ZONE WUJIANG, JIANGSU PROVINCE, CHINA
Address

氏名又は名称: SUZHOU WALTER ELECTRONIC CO., LTD.
Name

8. 適用試験規格: 電気用品の技術上の基準を定める省令の解釈
Applied Standard for Testing Description of the technical requirements by the METI Ordinance
別表第三2

Appendix 3 Section 2

9. 適合性検査の方法: (Testing Method for Conformity Assessment)

- 1) 試験用の特定電気用品については、電気用品の技術上の基準を定める省令の解釈に定める方法

With respect to testing for Category A products, the testing method is based on the technical requirements of the description of Electrical Appliances and Materials stipulated in the METI Ordinance.

- 2) 当該特定電気用品に係る届出事業者又は事業場における検査設備については、電気用品安全法施行規則別表第四の検査設備の欄に掲げる検査設備ごとにそれぞれ同表の技術上の基準の欄に掲げる方法

With respect to inspection facilities required for Category A products at the factory, Testing Method described in the column of the technical requirements for each inspection facilities in the column of inspection facilities is shown in the Appendix 4 of Enforcement Regulations of the Act.

10. 注意事項

- 1) この適合同等証明書は、提出された試験用の電気用品に関して評価を行った上で交付したものであり、同一の型式の区分にある電気用品について電気用品安全法第8条1項に規定する技術基準適合確認の義務を履行したことを示すものではありません。

This Statement of Conformity Assessment, which is issued on the evaluation of the submitted test-use Electrical Appliances and Materials, does not signify that the Obligation to Comply with Requirements, which is prescribed at Paragraph 1 of Article 8 of the Act, is fulfilled on Electrical Appliances and Materials in the same Type Classification.

- 2) この適合同等証明書は、別紙に記載されている型式の区分の範囲内及び区分の組み合わせについてのみ有効です。

This Statement of Conformity Assessment is valid only for Electrical Appliances and Materials within the Type Classifications and their combination as stated in the attached "Type Classification".

順海科技
0755-28100016

一般財団法人 電気安全環境研究所
Japan Electrical Safety & Environment technology Laboratories (JET)

理事長 薦田 康久
President Yasuhisa Komoda

東京都渋谷区代々木5-14-12
(5-14-12, Yoyogi, Shibuya-ku, Tokyo, Japan)

証明書番号：JET2179-31007-1001

適合同等証明書別紙

Statement of Conformity Assessment

型式の区分

Type Classification

要素 Factor	区分 Classification
定格電圧 Rated voltage	(2) 125Vを超えるもの Exceeding 125V
定格電流（定格電流表示のあるものに限る。） Rated current (limited to those with rated current markings)	(2) 5Aを超え15A以下のもの Exceeding 5A, and less than or equal to 15A
適用電動機の定格容量（定格電流表示のないものに限る。） Rated capacity of applicable motor (limited to those without rated current markings)	—
可溶体の主材料 Fuse element materials	(5) 銅のもの Copper
可溶体の数 Number of fuse elements	(1) 1のもの One
再使用（管形ヒューズを除く。） Reusability (excluding cartridge fuses)	(2) できないもの Not reusable
内部充てん物 Filler materials	(1) あるもの With filler materials
筒（内筒を除く。）の材料 Outer cartridge materials	(7) その他のもの Others
端子 Terminals	(5) その他のもの Others
排気孔 Exhausting opening	(2) ないもの Without exhausting opening
溶断の表示 Blowout fuse indicator	(2) ないもの Without blowout fuse indicator
用途 Application	(2) 電子機器用のもの For use in electric appliances
定格遮断電流 Rated breaking capacity	(1) 100A以下のもの 100A or less

証明書番号：JET2179-31007-1001

適合同等証明書

Statement of Conformity Assessment

電気用品安全法第8条第1項に規定する技術基準及び同法第9条第2項の経済産業省令で定める基準（法第9条第1項第2号に係る検査に係るものに限る）に適合していることを証明します

I hereby certify that the product mentioned below complies with the technical requirements stipulated in Paragraph 1 of Article 8 of Electrical Appliances and Materials Safety Act (here under referred to as the Act) and the requirements defined by the ordinance of the Ministry of Economy, Trade and Industry based on Paragraph 2 of Article 9 of the Act (limited to Item 2 of Paragraph 1 of Article 9 for Inspection of the Act).

1. 証明書番号: JET 2179-31007-1002
Statement Number
2. 交付年月日: 2019年9月29日
Effective Date September 29, 2019
3. 有効年月日: 2026年9月28日
Date of Validity September 28, 2026
4. 申込者名 (Applicant)
住所: FENHU TECHNIC DEVELOPMENT ZONE WUJIANG, JIANGSU PROVINCE, CHINA
Address

氏名又は名称: SUZHOU WALTER ELECTRONIC CO., LTD.
Name

5. 特定電気用品名: その他の包装ヒューズ
Name of Product Other enclosed fuses
6. 型式の区分: 別紙のとおり
Type Classification See attached "Type Classification"
7. 製造工場名 (Manufacturer)
住所: FENHU TECHNIC DEVELOPMENT ZONE WUJIANG, JIANGSU PROVINCE, CHINA
Address

氏名又は名称: SUZHOU WALTER ELECTRONIC CO., LTD.
Name

8. 適用試験規格: 電気用品の技術上の基準を定める省令の解釈
Applied Standard for Testing Description of the technical requirements by the METI Ordinance
別表第三2

Appendix 3 Section 2

9. 適合性検査の方法: (Testing Method for Conformity Assessment)

- 1) 試験用の特定電気用品については、電気用品の技術上の基準を定める省令の解釈に定める方法

With respect to testing for Category A products, the testing method is based on the technical requirements of the description of Electrical Appliances and Materials stipulated in the METI Ordinance.

- 2) 当該特定電気用品に係る届出事業者又は事業場における検査設備については、電気用品安全法施行規則別表第四の検査設備の欄に掲げる検査設備ごとにそれぞれ同表の技術上の基準の欄に掲げる方法

With respect to inspection facilities required for Category A products at the factory, Testing Method described in the column of the technical requirements for each inspection facilities in the column of inspection facilities is shown in the Appendix 4 of Enforcement Regulations of the Act.

10. 注意事項

- 1) この適合同等証明書は、提出された試験用の電気用品に関して評価を行った上で交付したものであり、同一の型式の区分にある電気用品について電気用品安全法第8条1項に規定する技術基準適合確認の義務を履行したことを示すものではありません。

This Statement of Conformity Assessment, which is issued on the evaluation of the submitted test-use Electrical Appliances and Materials, does not signify that the Obligation to Comply with Requirements, which is prescribed at Paragraph 1 of Article 8 of the Act, is fulfilled on Electrical Appliances and Materials in the same Type Classification.

- 2) この適合同等証明書は、別紙に記載されている型式の区分の範囲内及び区分の組み合わせについてのみ有効です。

This Statement of Conformity Assessment is valid only for Electrical Appliances and Materials within the Type Classifications and their combination as stated in the attached "Type Classification".

順海科技
0755-28100016

一般財団法人 電気安全環境研究所
Japan Electrical Safety & Environment technology Laboratories (JET)

理事長 薦田 康久
President Yasuhisa Komoda

東京都渋谷区代々木5-14-12
(5-14-12, Yoyogi, Shibuya-ku, Tokyo, Japan)

証明書番号 : J E T 2 1 7 9 - 3 1 0 0 7 - 1 0 0 2

適合同等証明書別紙

Statement of Conformity Assessment

型式の区分

Type Classification

要素 Factor	区分 Classification
定格電圧 Rated voltage	(2) 125Vを超えるもの Exceeding 125V
定格電流（定格電流表示のあるものの場合に限る。） Rated current (limited to those with rated current markings)	(1) 5 A以下のもの 5A or less
適用電動機の定格容量（定格電流表示のないものの場合に限る。） Rated capacity of applicable motor (limited to those without rated current markings)	—
可溶体の主材料 Fuse element materials	(5) 銅のもの Copper
可溶体の数 Number of fuse elements	(1) 1のもの One
再使用（管形ヒューズを除く。） Reusability (excluding cartridge fuses)	(2) できないもの Not reusable
内部充てん物 Filler materials	(1) あるもの With filler materials
筒（内筒を除く。）の材料 Outer cartridge materials	(7) その他のもの Others
端子 Terminals	(5) その他のもの Others
排気孔 Exhausting opening	(2) ないもの Without exhausting opening
溶断の表示 Blowout fuse indicator	(2) ないもの Without blowout fuse indicator
用途 Application	(2) 電子機器用のもの For use in electric appliances
定格遮断電流 Rated breaking capacity	(1) 100 A以下のもの 100A or less

証明書番号：JET2179-31007-1002

접수번호 : 12-1920-0341
(Receipt No.)



전기용품안전인증서

Electrical Appliances Safety Certificate

안전인증번호 : SU05015-12002
(Certificate No.)

제조업자명 : Suzhou Walter Electronic Co., Ltd.
(Factory)

대표자명 : Mr. Yen Chun Chang
(President)

제조공장의소재지 : Fenhu, Technic Development Zone, Luxu Wu Jiang, Jiangsu, P.R.China
(Factory Address)

제품명 : 퓨즈(Sub-miniature fuse-links)
(Product)

기본모델명 : 2010 6.3A 250V
(Basic Model)

정격 : T6.3A 250Vac
(Rating)

파생모델명 : 2010 3.15A 250V, 2010 4A 250V, 2010 5A 250V
(Series Model)

적용기준 : K60127-1(2011-12), K60127-3(2006-07)
(Standard)

「전기용품안전 관리법 시행규칙」 제6조제2항에 따라 위의 전기용품에 대하여 안전인증서를 발급합니다.

We Issue Electrical Appliances Safety Certification as above product by Article 6 Section 2 of the Electrical Appliances Safety Control Law Enforcement Regulation.

2012년 02월 15일
year month day



한국산업기술시험원장
KOREA TESTING LABORATORY



* 이 인증서는 「전기용품안전 관리법」에 따른 전기용품 안전성 확인에 한정된 것이며, 그 밖의 다른 법률이 적용되는 제품의 경우에는 해당 법률에 따라 추가로 인증·허가 등을 받아야 합니다.

- 첨부 : 1. 안전관리부품 및 재질목록 (List of Critical Components)
(Annex) 2. 기본모델·파생모델의 내용 (General Descriptions of Certified Products)
3. 전기용품안전인증의 변경 현황 (Status of Certificate Revisions)

첨부 2 : 기본모델 · 파생모델의 내용
General description of Certified Products

파생모델명 Derivative model	기본모델과의 차이점 Differences between the basic and derivative model(s)
2010 3.15A 250V	Rated current(3.15A) is different
2010 4A 250V	Rated current(4A) is different
2010 5A 250V	Rated current(5A) is different
제품특기사항 및 시험조건 Remarks & Test conditions	
<p>1. Test Report Ref. No. : 12-1920-0341 (2012.02.14.)</p> <p>2. Product Description</p> <ul style="list-style-type: none"> - 6.3A 250Vac - Breaking capacity : 130A - Time lag type, Low-breaking capacity - Standard sheet 4 	
<p><input type="checkbox"/> 본 제품의 시험내용에 관하여 문의하실 사항이 있으시면 아래 연락처로 문의하시기 바랍니다. 시험 담당자 / 연락처: 디지털산업본부 전기전자기술센터 조인철 / (02)860-1425</p> <p><input type="checkbox"/> If you have any question on product testing, please contact the person below : Job holder: Digital Industry Division, Electrics & Electronics Technology Center, INCHUL CHO/+82 2 8601-425</p>	

FP511-09-00

첨부 3 : 전기용품안전인증의 변경 현황
Status of Certificate Revisions

변경발급 내용 Contents of Certificate Revisions
Not applicable

FP511-11-00

접수번호 : 12-1920-1601
(Receipt No.)



전기용품안전인증서

Electrical Appliances Safety Certificate

안전인증번호 : SU05015-12008
(Certificate No.)

제조업자명 : Suzhou Walter Electronic Co., Ltd.
(Factory)

대표자명 : Mr. Yen Chun Chang
(President)

제조공장의
소재지 : Fenhu, Technic Development Zone, Luxu Wu Jiang, Jiangsu,
(Factory Address) P.R.China

제품명 : 퓨즈(Sub-miniature fuse-links)
(Product)

기본모델명 : 2010 T2.5A 250V
(Basic Model)

정격 : 250 V 2.5 A, 1.25 A
(Rating)

파생모델명 : See the attachment 2
(Series Model)

적용기준 : K60127-1(2011-12), K60127-3(2006-07)
(Standard)

「전기용품안전 관리법 시행규칙」 제6조제2항에 따라 위의 전기용품에 대하여
안전인증서를 발급합니다.

We Issue Electrical Appliances Safety Certification as above product by Article 6 Section 2
of the Electrical Appliances Safety Control Law Enforcement Regulation.

2012년 05월 11일
year month day

ktl 한국산업기술시험원장
KOREA TESTING LABORATORY



* 이 인증서는 「전기용품안전 관리법」에 따른 전기용품 안전성 확인에 한정된 것이며, 그 밖의 다른
법률이 적용되는 제품의 경우에는 해당 법률에 따라 추가로 인증·허가 등을 받아야 합니다.

- 첨부 : 1. 안전관리부품 및 재질목록 (List of Critical Components)
(Annex) 2. 기본모델·파생모델의 내용 (General Descriptions of Certified Products)
3. 전기용품안전인증의 변경 현황 (Status of Certificate Revisions)

첨부 2 : 기본모델 · 파생모델의 내용
General description of Certified Products

파생모델명 Derivative model	기본모델과의 차이점 Differences between the basic and derivative model(s)
2010 T1A 250V	Rated current is different (250V 1A)
2010 T1.25A 250V	Rated current is different (250V 1.25A)
2010 T1.6A 250V	Rated current is different (250V 1.6A)
2010 T2A 250V	Rated current is different (250V 2A)
제품특기사항 및 시험조건 Remarks & Test conditions	
<p>1. Test Report Ref. No. : 12-1920-1601 (2012.05.10.) Review Report Ref. No. : 2012TS00495 (2012.03.15.)</p> <p>2. Product Description</p> <ul style="list-style-type: none"> - 250 V 2.5 A - Rated breaking capacity : 130 A - Standard sheet 4 	
<p><input type="checkbox"/> 본 제품의 시험내용에 관하여 문의하실 사항이 있으시면 아래 연락처로 문의하시기 바랍니다. 시험 담당자 / 연락처: 디지털산업본부 전기전자기술센터 조인철 / (02)860-1425</p> <p><input type="checkbox"/> If you have any question on product testing, please contact the person below : Job holder: Digital Industry Division, Electrics & Electronics Technology Center, INCHUL CHO/+82 2 8601-425</p>	

FP511-09-00

첨부 3 : 전기용품안전인증의 변경 현황
Status of Certificate Revisions

변경발급 내용 Contents of Certificate Revisions
Not applicable

FP511-11-00

접수번호 : 12-1920-1599
(Receipt No.)



전기용품안전인증서

Electrical Appliances Safety Certificate

안전인증번호 : SU05015-12007
(Certificate No.)

제조업자명 : Suzhou Walter Electronic Co., Ltd.
(Factory)

대표자명 : Mr. Yen Chun Chang
(President)

제조공장위치 : Fenhua, Technic Development Zone, Luxu Wu Jiang, Jiangsu,
(Factory Address) P.R.China

제품명 : 퓨즈(Sub-miniature fuse-links)
(Product)

기본모델명 : 2010 T100mA 250V
(Basic Model)

정격 : 250 V 100 mA, 130 A
(Rating)

파생모델명 : Not Applicable
(Series Model)

적용기준 : K60127-1(2011-12), K60127-3(2006-07)
(Standard)

「전기용품안전 관리법 시행규칙」 제6조제2항에 따라 위의 전기용품에 대하여 안전인증서를 발급합니다.

We issue Electrical Appliances Safety Certification as above product by Article 6 Section 2 of the Electrical Appliances Safety Control Law Enforcement Regulation.

2012년 05월 09일
year month day



한국산업기술시험원장
KOREA TESTING LABORATORY



* 이 인증서는 「전기용품안전 관리법」에 따른 전기용품 안전성 확인에 한정된 것이며, 그 밖의 다른 법률이 적용되는 제품의 경우에는 해당 법률에 따라 추가로 인증·허가 등을 받아야 합니다.

- 첨부 : 1. 안전관리부품 및 재질목록 (List of Critical Components)
(Annex) 2. 기본모델·파생모델의 내용 (General Descriptions of Certified Products)
3. 전기용품안전인증의 변경 현황 (Status of Certificate Revisions)

접수번호 : 12-1920-1589
(Receipt No.)



전기용품안전인증서

Electrical Appliances Safety Certificate

안전인증번호 : SU05015-12006
(Certificate No.)

제조업자명 : Suzhou Walter Electronic Co., Ltd.
(Factory)

대표자명 : Mr. Yen Chun Chang
(President)

제조공장의 소재지 : Fenhui, Technic Development Zone, Luxu Wu Jiang, Jiangsu,
(Factory Address) P.R.China

제품명 : 퓨즈(Sub-miniature fuse-links)
(Product)

기본모델명 : 2010 T800mA 250V
(Basic Model)

정격 : 250 V 800 mA / 30 A
(Rating)

파생모델명 : See the attachment 2
(Series Model)

적용기준 : K60127-1(2011-12), K60127-3(2006-07)
(Standard)

「전기용품안전 관리법 시행규칙」 제6조제2항에 따라 위의 전기용품에 대하여 안전인증서를 발급합니다.

We Issue Electrical Appliances Safety Certification as above product by Article 6 Section 2 of the Electrical Appliances Safety Control Law Enforcement Regulation.

2012년 05월 09일
year month day

ktl

한국산업기술시험원

KOREA TESTING LABORATORY



* 이 인증서는 「전기용품안전 관리법」에 따른 전기용품 안전성 확인에 한정된 것이며, 그 밖의 다른 법률이 적용되는 제품의 경우에는 해당 법률에 따라 추가로 인증·허가 등을 받아야 합니다.

- 첨부 : 1. 안전관리부품 및 재질목록 (List of Critical Components)
(Annex) 2. 기본모델·파생모델의 내용 (General Descriptions of Certified Products)
3. 전기용품안전인증의 변경 현황 (Status of Certificate Revisions)

첨부 2 : 기본모델 · 파생모델의 내용
General description of Certified Products

파생모델명 Derivative model	기본모델과의 차이점 Differences between the basic and derivative model(s)
2010 T125mA 250V	Rated current is different (250V 125mA)
2010 T160mA 250V	Rated current is different (250V 160mA)
2010 T200mA 250V	Rated current is different (250V 200mA)
2010 T250mA 250V	Rated current is different (250V 250mA)
2010 T315mA 250V	Rated current is different (250V 315mA)
2010 T400mA 250V	Rated current is different (250V 400mA)
2010 T500mA 250V	Rated current is different (250V 500mA)
2010 T630mA 250V	Rated current is different (250V 630mA)
제품특기사항 및 시험조건 Remarks & Test conditions	
<p>1. Test Report Ref. No. : 12-1920-1589 (2012.05.10.) Review Report Ref. No. : 2012TS00498 (2012.03.15.)</p> <p>2. Product Description</p> <ul style="list-style-type: none"> - 250 V 800 mA - Rated breaking capacity : 130 A - Standard sheet 4 	
<p><input type="checkbox"/> 본 제품의 시험내용에 관하여 문의하실 사항이 있으시면 아래 연락처로 문의하시기 바랍니다. 시험 담당자 / 연락처: 디지털산업본부 전기전자기술센터 조인철 / (02)860-1425</p> <p><input type="checkbox"/> If you have any question on product testing, please contact the person below : Job holder: Digital Industry Division, Electrics & Electronics Technology Center, INCHUL CHO/+82 2 8601-425</p>	

FP511-09-00

첨부 3 : 전기용품안전인증의 변경 현황
Status of Certificate Revisions

변경발급 내용 Contents of Certificate Revisions
Not applicable

FP511-11-00